

30 YEARS

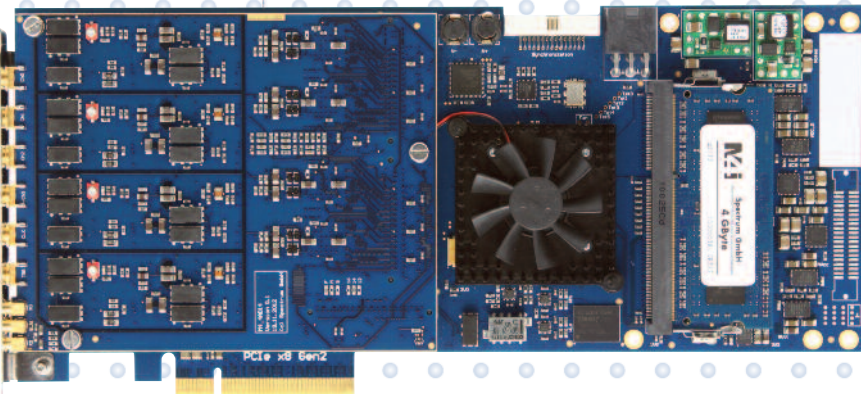

SPECTRUM
INSTRUMENTATION

Perfect fit – modular designed solutions

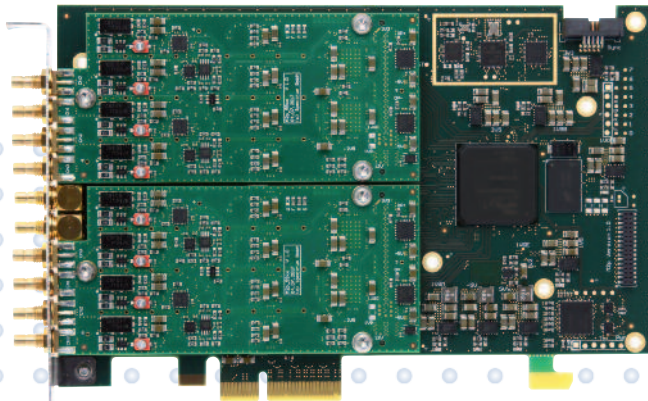

2020

Digitizers | Transient Recorders | Arbitrary Waveform Generators | Digital Waveform Acquisition Cards
for PCI Express, PXI Express and LXI / Ethernet



SPECTRUM



Trg7

X2

X1

X0

Clk In

Trg0



Dear Business Partners and Friends,

This hot-off-the-press catalog that you're holding is our anniversary edition, so to say, as we are celebrating 30 years of Spectrum in 2019. For me as founder and managing director, a look back over the years is reason for rejoicing.

There is great pleasure in seeing that the company has remained on the road to success over a long period – with growth in the double-digit percentage range in the past seven years and a worldwide sales network representing us in 39 countries.

I also derive pleasure from the team of employees who have made this success possible by sharing and living the values on which our company is founded. To them I give special thanks for their engagement.

Finally, there's pleasure in knowing that staying true to personal values and convictions as the basis for managing a company not only contributes to individual satisfaction, but also leads to economic success.

Continuity, customer orientation, quality and moderate organic growth are the basis for our work. We maintain long-term relationships to customers, distributors and vendors; the oldest contacts go back to the early 1990s and still exist today! To the delight of our customers, our products are available over a long time, which is highly unusual in our industry. We recently set a new standard in our line of business by extending the product warranty to five years.

Today, after 30 years, I can say that our way of working has proven to be effective and our labors have continuously borne fruit. We are well equipped for the future, having modernized and expanded our production department in terms of efficiency, ergonomics and job creation, and will continue to pursue our solid course.

For your loyalty and attachment to our company I give you my heartfelt thanks. We are and will remain the reliable partner at your side.

Yours,

Gisela Hassler
Managing Director

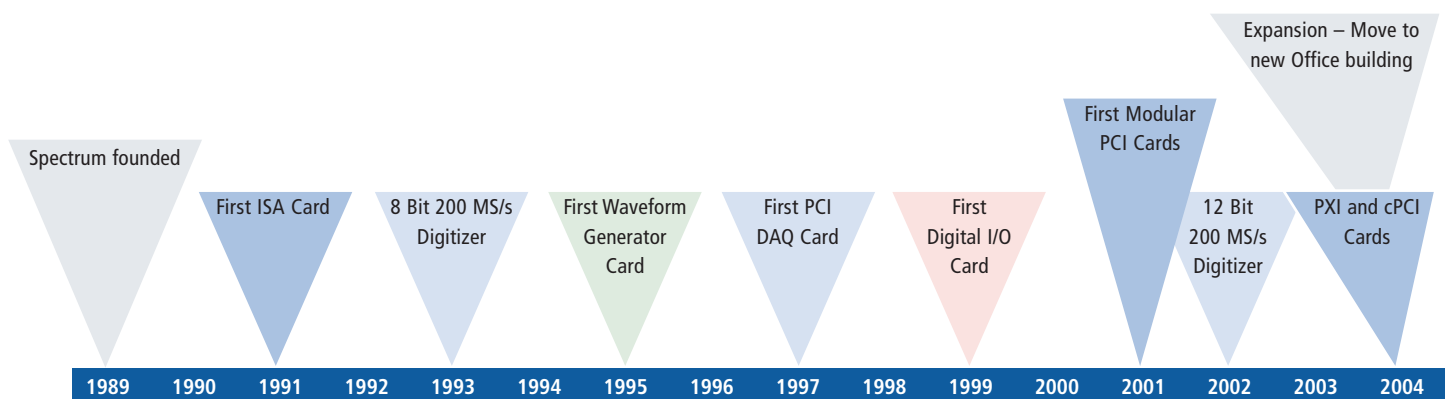

Dear Valued Customer,

Spectrum has seen a lot of change in the past 30 years. What has remained the same since 1995 when I started as a software developer (and fourth employee) is the company's focus on customer success and long-term partnerships. In fact, some of today's customers and distribution partners have been working with Spectrum since the early days.



In 2000 after her co-founder left the company, Gisela Hassler, CEO and founder of Spectrum, put her trust in me and appointed me technical director. That was a big personal step and the start of the modular instrumentation concept that is still the basis for all products today.

The idea was to split the product into several modules which also are used in other products. That allowed us to launch different digitizers based on the same carrier card. Years later the concept was summed up in the marketing phrase "Perfect fit, modular designed solutions". The high variety of products with different channel configurations, speed grades and options allows the customer to select the perfect fit.

With the growth of the company my job changed from software to hardware engineer, to technical director, sales manager and organizer. Nowadays a product design is the joint success of a full team of enthusiastic engineers, with manufacturing handled by a precision-minded production team and sales/export managed by a versatile office team. Low staff turnover and years of service have allowed Spectrum to build up a great base of experience and knowledge.

When people visit Spectrum they always tell us that we look more like a big family than a company. Everybody contributes what is possible and looks for ways to make improvements. That leads to very high quality products, support and customer relations.

With the new M2p series released in 2018 and 2019, the last product was discontinued which I personally designed sometime back in 2003.

When I started at Spectrum I had no idea how the company would look after 30 years on the market. Back then a large order led to hours or days of hand-soldering by everybody. Today our fully organized production line with automatic tests and measurements outputs products of the highest quality.

Now I'm looking forward to the coming years, the new products we've planned and future improvements to the company.

Yours Sincerely,

Oliver Rovini
Technical Director

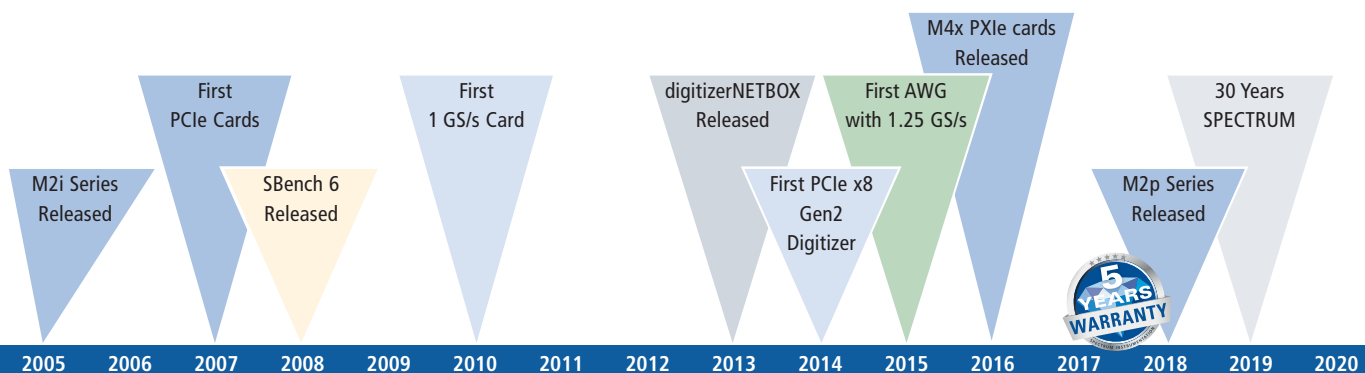

History

1989

SPECTRUM was founded by Gisela Hassler and Michael Janz with the business objective of developing custom-built instrumentation. They started developing an own product line and created the first ISA card in 1991. This digitizer card with 50 MHz and 8 bit called "PAD52" was sold for 17 years until 2008! Many other ISA digitizers and the first Arbitrary-Waveform-Generator-cards followed in the next years.

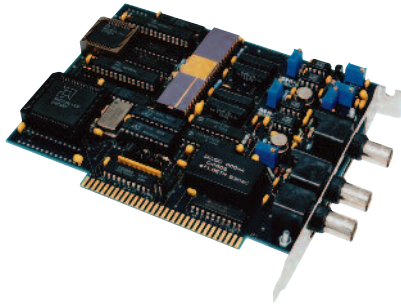

1996

SPECTRUM created its first 12 bit digitizer card for the new bus standard PCI with a sampling rate of 80 MS/s. Many other PCI based cards followed.

2000 and 2001

Oliver Rovini, who joined the company in 1995 as a software engineer, takes over the position of the Technical Manager after founder Michael Janz left the company. It was Oliver's idea to build modular PCI products, consisting of the same platform card and several different modules. This quickly led to a large range of digitizers, AWGs and digital I/O boards.

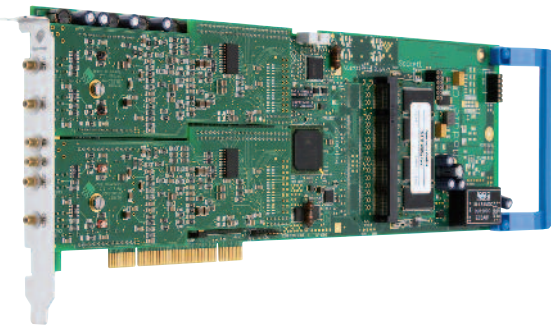

2004

Based on the existing MI series and with the benefit of the modular system, a complete range of CompactPCI and PXI cards were launched.

Second, SPECTRUM introduced the M2i series, the successor of the MI cards with a better interface, more memory and more features.

From 2000 to 2004, thanks to the modular system, the number of different products grew from 18 to 170!

And third, in April the company moved to a much larger building with special areas for the development, production and office.

2007

All 90 cards of the M2i-series became available as PCI Express version – the latest bus standard for PC based systems.

2008

SBench 6 measurement software was introduced. The software is intuitive to use for comfortable and fast data acquisition and analysis of GByte of analog and digital data in addition to its powerful export and report functions. SBench 6 quickly became a very popular tool.

2009

In the year 2009, the M3i series was introduced, starting with a 500 MS/s digitizer and followed by a digitizer card reaching 1 GS/s speed a year later. Meanwhile, the cards of the MI and M2i series were successfully sold around the world, being used in many companies, universities and for many OEM products. All three series formed a range of 320 different products!

2011

SPECTRUM delivered 140 digitizer cards to CERN. Since then, they are used to control the Beam Dumping System of the LHC, the largest particle accelerator in the world.



2013

To support the growing business in Asia, Spectrum appointed Gregory Tate as Asian Business Manager. Greg has 30 years of experience in electronics and a deep knowledge of digitizer technology, modular instrumentation and their applications in the Asian market.

A totally new product group was launched, the "digitizerNET-BOX". This stand-alone unit contains two Spectrum digitizers cards, offering up to 16 fully synchronized data acquisition channels in one small box with fully remote control via Ethernet/LXI from any PC or network.



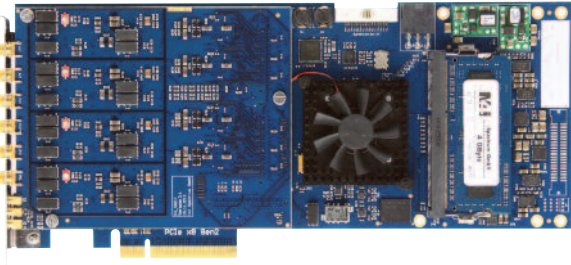

2014

SPECTRUM released the M4i series with 5 GS/s sampling speed! These very fast cards opened new application areas down into the sub-nanosecond range.

2015

In the beginning of this year, SPECTRUM opened its own US office caring for the growing US market and the increasing number of manufacturing representatives. In over 30 other countries, Spectrum already announced distributors to enhance the global sales.

The new M4i series was extended with Arbitrary Waveform Generators offering up to 1.25 GS/s of data generation rate.



2016

Spectrum released PXIe version of all its fast M4i-series Digitizers and AWGs. The PXIe cards share the same driver interface and are 100 % software compatible to the PCIe cards.

Also, the larger version of the digitizerNETBOX was introduced: Containing up to 6 Spectrum cards, this stand-alone unit offers up to 48 synchronous channels in one 19" chassis with total remote control via Ethernet/LXI.

2017

Since the beginning, all Spectrum products are completely designed, built and tested in Germany showing an extremely low failure rate, so SPECTRUM increased the warranty for their products from 2 years to industry-leading 5 years.

The quality of Spectrum cards can be seen e.g. at DESY in Hamburg, where they control all three particle accelerators for 15 years without problems, or in Antarctica, as the heart of an atmospheric measurement system of the Leibniz-Institute working precisely on its own for weeks and months in ice and snow.

Also, in this year, the "Spectrum Systementwicklung Microelectronic GmbH" changed its name to the internationally much more understandable "Spectrum Instrumentation GmbH".



2018

Spectrum launched a new series called "M2p", with the PCIe platform board being only 168 mm in length, with many different modules forming digitizers and AWGs in the range of 5 MS/s to 125 MS/s with up to 8 channels on a single card.

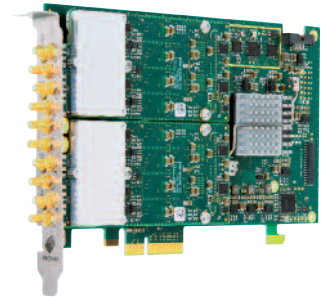

2019

With the release of the M2p AWG Spectrum finished the replacement of the older product ranges MI, M2i and M3i and now has a modern range of nearly 200 instrumentation products, all designed within the last 5 years.

The more than 400 obsolete products are still in production for existing customers to allow a smooth replacement inside the various projects.

6. December 2019 – 30th Anniversary

In 30 years, SPECTRUM was able to gain customers all around the world, including many A-brand industry-leaders, as well as 100's of different universities and research institutes.

Spectrum digitizers and AWGs are used in world-leading R&D projects, like a 256-channel digitizer system which helps the British company FLF to build a fusion reactor within 4 years.

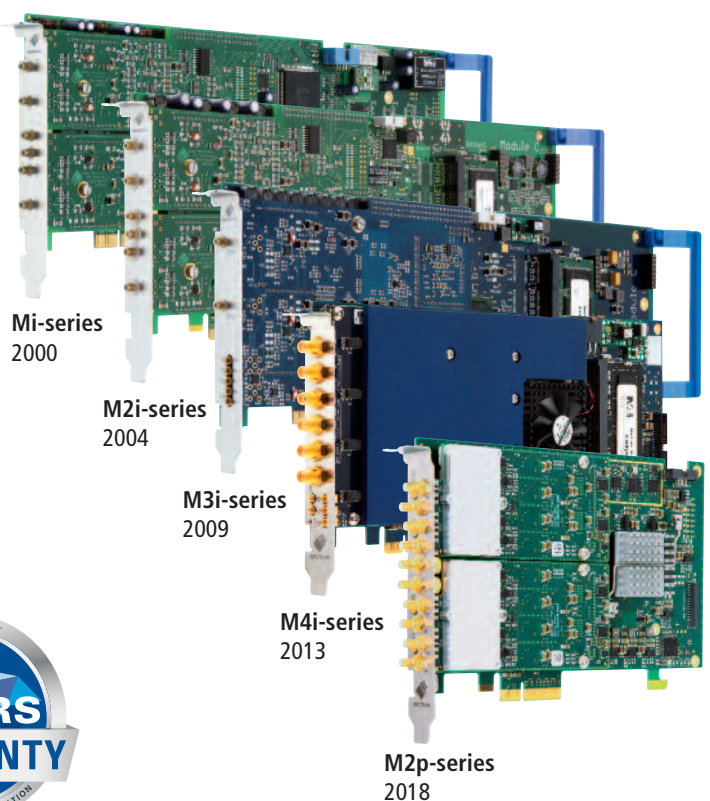

Mi-series
2000

M2i-series
2004

M3i-series
2009

M4i-series
2013

M2p-series
2018

Spectrum's Philosophy

Designed to Last

At Spectrum we believe in long-term partnerships. If it is necessary to end a product line due to obsolete parts we help with the transition to successor products. Furthermore all products that have been released since 2000 are available for existing customers as long as we get the parts on the market. Support, updates, repairs and calibration is part of the long life cycle.

Modularity Brings Flexibility

Spectrum has a unique design philosophy. By using a modular design, platform boards are populated with different analog and digital daughter-boards as required to create a wide range of performance options – ensuring a perfect match against the required specifications of customers. This allows users to get exactly the specifications that they need without compromise, without delay, and without the price premium of a one-off custom product.

Production and Pricing

The modular approach enables Spectrum to mass-produce platform boards and daughter-boards. We then pass on the cost savings of this method to our customers, ensuring Spectrum is always competitively priced. It gives purchasers the advantages of a customized solution without a price premium – often more competitively priced than rivals' standard products – all thanks to the benefits of mass-produced modular design.

Rapid Time to Customer

Spectrum's modular design also enables products to be rapidly built to order and fully tested from stock boards so that customers receive their deliveries quickly.

Wide Selection Choice

To match as many applications as possible Spectrum offers the widest range and choice. Digitizers are available with sampling rates from as low as 5 MS/s to as high as 5 GS/s, allowing you to capture signals from the Hz to the GHz range. Models offer vertical resolution from 8 to 16 Bits and they're optimized for dynamic performance to ensure the best possible accuracy and precision. Acquired signals can be stored in large on-board memories, processed using the latest FPGA technology, or transferred directly to other devices such as GPU cards and external storage devices via a variety of versatile readout modes. Similarly, our AWGs offer output rates from 40 MS/s up to 1.25 GS/s making them suitable for producing almost any wave shape with signal frequency content from DC to 400 MHz or as an option even up to 600 MHz.

Customized Products

If you can't find the product you need in this catalog then let us know your mandatory specifications and we will be happy to investigate the possibility of making a customized product just for you!

Perfect fit – modular designed solutions



Support and Warranty

Customer satisfaction is our highest priority so when you buy a Spectrum product we expect you will be pleased. All our products are designed and manufactured in Germany where we endeavor to attain the highest quality and reliability. The same philosophy applies to technical support. Our engineers are at your disposal. Need help on a software or hardware issue? Just send us a message to support@spec.de and our engineers will respond to you directly. You can have confidence that your message will be answered by the right specialist for the task. All the technical support from our engineers and partners is free, with no hidden charges. Spectrum products are covered by an industry leading five years warranty while software and driver updates are available to download free of charge from our website for the life-time of the product.

In the unusual event that a repair is necessary our service department will assist you to make it happen as quickly and efficiently as possible. We will diagnose the problem and then help you to get the repair made in the fastest and most cost effective way.

Spectrum also offers a complete calibration service. Calibration is performed with fully certified instruments ensuring traceability and specification confidence. All products are manufactured and tested to meet our rigid design standards and they are shipped with the CE mark to certify that they meet all the necessary requirements of the European CE directives.

- Prefaces Page 4
- History Page 6
- Spectrum’s Philosophy Page 8
- Applications Page 10
- PCIe Platform Page 12
- PXIe Platform Page 13
- Ethernet Platform Page 14

Digitizers

- Digitizers Page 16
- Features & Modes Page 17
- 22xx Series – Ultra High-Speed 8 Bit Digitizers up to 5 GS/s Page 18
- 44xx Series – High-Resolution High-Speed Digitizers up to 500 MS/s Page 20
- 59xx Series – 16 Bit General Purpose Digitizers up to 125 MS/s Page 22

Arbitrary Waveform Generators

- Arbitrary Waveform Generators Page 24
- Features & Modes Page 25
- 66xx Series – 16 Bit High-Speed Arbitrary Waveform Generators up to 1.25 GS/s Page 26
- 65xx Series – **NEW AWG SERIES 2019** Page 28

Digital Data Acquisition

- Digital Data Acquisition Page 30
- 77xx Series – 32 Channel Digital Waveform Acquisition Page 31

PC Systems

- Turn-Key High-Performance Streaming Systems Page 32
- Multi-Card PC Systems and Docking Stations Page 33
- Accessories Page 33

Software

- Software Page 34
- SCAPP GPU Support Page 37
- SBench 6 Page 38

- 10 Facts about Spectrum Page 41
- Publication Page 42
- Social Media Page 42
- Imprint Page 42



Communications

- 14 and 16 Bit Resolution
- Time and Frequency Domain Analysis
- Advanced Display Modes

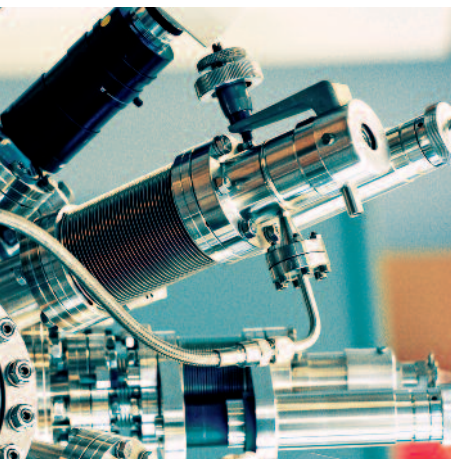

Spectroscopy

- Ultrafast Data Transfer
- Large Acquisition Memories
- On-Board Signal Averaging



Astronomy

- High Sampling Rates and Resolution
- Time and Frequency Domain Analysis
- Low-noise Front-End Circuitry

When it comes to applications where custom specific measurements are necessary, modular PC-based instrumentation offers a host of advantages over conventional stand-alone testing devices. The approach allows you to take advantage of the latest developments in PC technology: accessing the most powerful processors, fastest bus speeds, and state-of-the-art graphical tools. Furthermore, you have the unrivaled flexibility of creating your own application specific programs, selecting from an ever expanding array of shareware utilities, or utilizing a wide variety of third party analysis products.

Spectrum Instrumentation products are powerful and universal PC-based instruments that can be used in nearly any application that needs an interface between the electrical analog world and PC-based data analysis, calculation, display and storage. The scalability of the products covers anything from single channel OEM medical or ultrasound devices to multi-channel transmission and reception communication design. Intelligent designed synchronization structures allow to scale-up even to hundreds of synchronous fast channels.

This page shows a number of common application areas where Spectrum products are found.

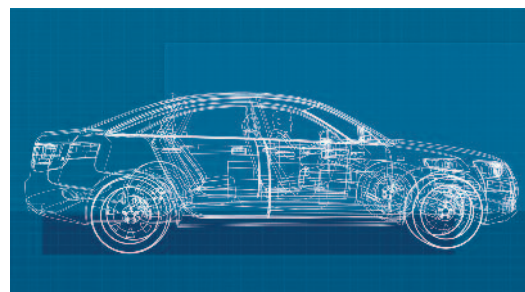

Automotive

- Acquisition and Replay of Analog and Digital Signals
- Combination of Slow and Fast Channels
- Portable (DC Supply) Systems



Acoustics

- Low-Noise and High Resolution
- Very high SNR (> 90 dB) and SFDR (>105 dB)
- Hundreds of Synchronous Channels



Big Physical Experiments

- Distributed Ethernet Acquisition
- High Channel Density with Hundreds of Synchronous Channels
- Combination of Slow and Fast Channels

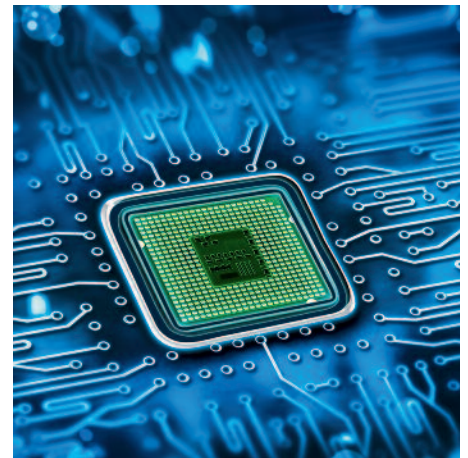

Semiconductor Tests

- LXI, PCIe and PXIe Modules
- Optimized SNR and SFDR
- Fully Functional Front-End Circuitry



Aerospace

- High Sampling Rates and Resolution
- Data Streaming and Storage
- Ultrafast Data Transfer (>3.4 GB/s)

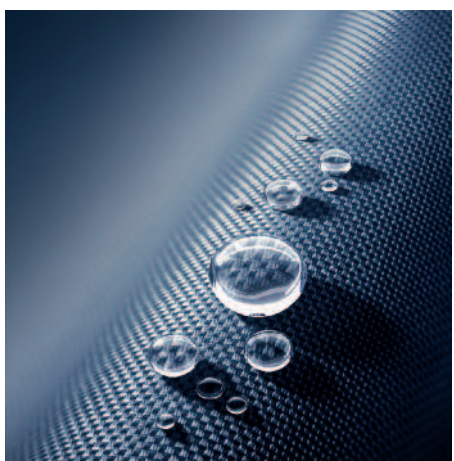

Nanotechnology

- Low-Noise High Dynamic Range Acquisition
- Precision Signal Generation
- High Gain Amplification

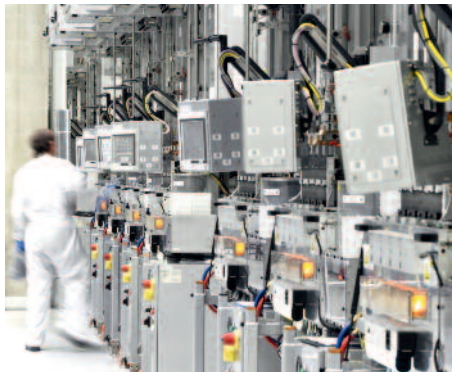

ATE – Automatic Test Equipment

- LXI and PXIe Modules
- Acquisition and Generation
- LabVIEW, MATLAB and IVI Interface

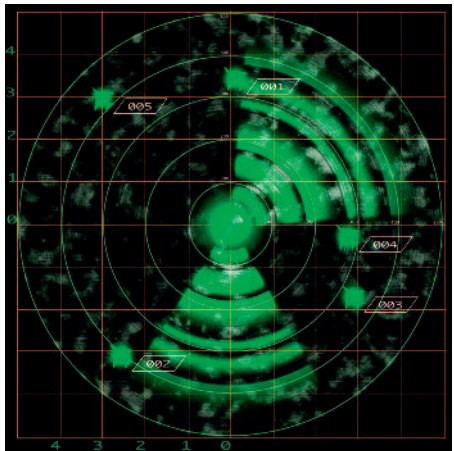

Radar

- 14 and 16 Bit Resolution
- Segmented Memory and FIFO Readout
- Acquisition and Generation (Continuous Radar Simulation)



LIDAR

- Advanced Acquisition and Readout Modes
- Block Averaging
- Low-Noise, High SNR

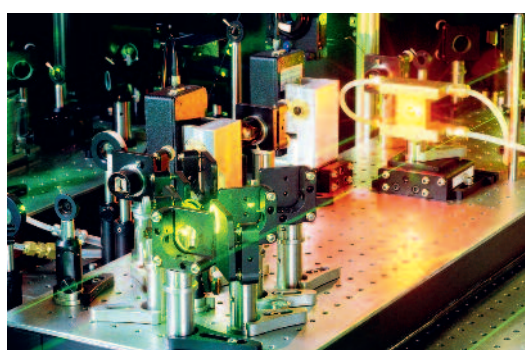

Laser

- 5 GS/s Sampling Rates and High Bandwidth
- Fast Trigger and Read-Out Rates
- On-Board Block Statistics (Peak Detection)

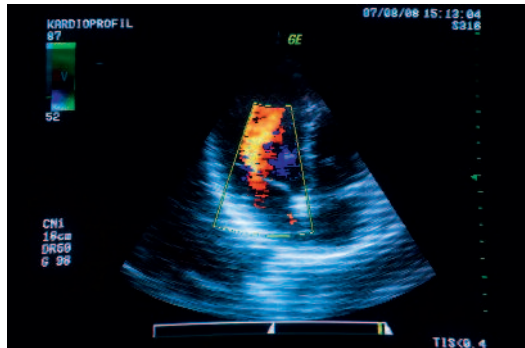

Ultrasound

- 14 and 16 Bit Resolution
- Segmented Memory with FIFO Readout
- Low Dead-Time Between Triggers (< 80 ns)



High Voltage Testing

- Fully Buffered Front-End Circuitry
- Single-Ended and Differential Inputs
- On-Board Block Statistics (Peak Detection)



Medical Science (OCT)

- High Sampling Rates and Resolution
- Fast Trigger and Read-Out Rates
- External Clock

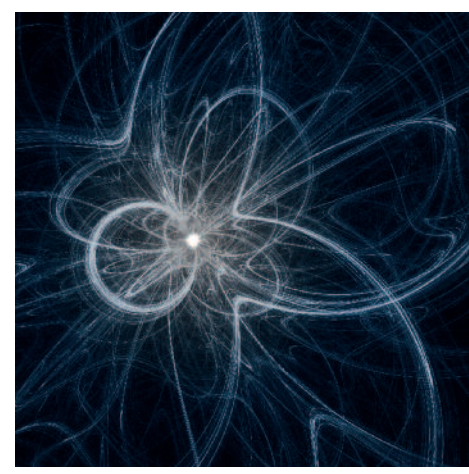

Quantum Science

- Versatile Signal Generation
- High Speed Data Streaming
- SCAPP GPU Support

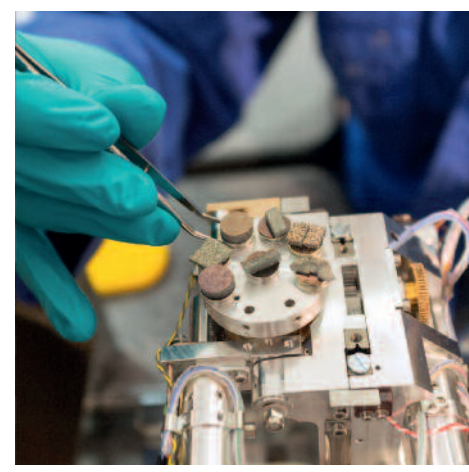

Materials Science

- Flexible Front-End Signal Conditioning
- High Resolution Recording
- Fully Synchronous Multi-Channel Acquisition

PCI Express is the standard platform for all current PC-based systems and also for the future. Today's state-of-the-art motherboards normally have a couple of PCI Express slots but only one or two PCI/PCI-X slots. The PCI Express bus is a point to point connection allowing full speed for every single slot. The Express bus is freely scaling and is available with 1 lane (x1), 4 lanes (x4), 8 lanes (x8) and 16 lanes (x16). For mechanical compatibility connectors may have more lanes than are connected to the motherboard.

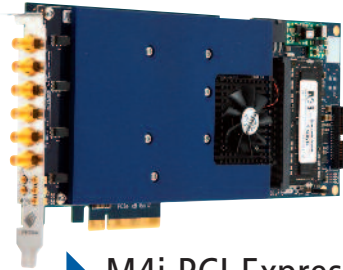

▶ M4i PCI Express Platform

- PCIe x8 Gen2 Interface
- more than 3.0 GByte/s streaming rate
- Star-Hub for internal synchronization up to 8 cards
- $\frac{3}{4}$ length (243 mm) single-slot card
- SMA and MMCX connections
- SCAPP option for CUDA-based calculations

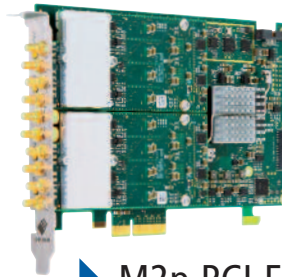

▶ M2p PCI Express Platform

- PCIe x4 Gen1 Interface
- more than 700 MByte/s streaming rate
- Star-Hub for internal synchronization up to 16 cards
- $\frac{1}{2}$ length (168 mm) single-slot PCIe card
- SMB and MMCX connections
- SCAPP option for CUDA-based calculations

▶ Advantages of the PCIe platform

- Universal bus system incorporated into millions of commercial and industrial systems world-wide
- Scalable PC platform from low-cost, low-end up to high-performance, multi-processor, multi-core
- Wide choice of components like ultra-low noise power supplies, additional interface cards or high-performance graphics cards
- Very fast backplane (PCIe lanes) – capable of very fast streaming to SSD arrays
- Direct interconnection with GPU for data processing possible (SCAPP option)
- Easy system extension via wide choice of PCIe extension components

▶ Outstanding Continuous Streaming Speed

The fast PCI Express interface of the Spectrum cards together with the optimized firmware and kernel driver allows a sustained acquisition streaming speed between card and PC. The on-board memory is completely used as a FIFO buffer to ensure the maximum throughput over a long time even with parallel PC activities. This outstanding streaming speed together with the intelligent memory segmentation modes fulfills even the most demanding application needs.

The M4i series is using PCIe x8 Gen2 interface with more than 3 GByte/s reaching 3.4 GByte/s on selected motherboards. A gap free streaming of for example one channel 8 bit acquisition with 2.5 GS/s or four channels 14 bit acquisition 400 MS/s is easy to achieve. Using a SSD RAID 0 array with a dedicated RAID controller one can even store this amount of data continuously to disk array.



Digital Option

The digital expansion module adds 16 additional, programmable digital I/O lines to the M2p card. These lines can acquire digital channels synchronously with the analog channels when used on a digitizer card and can be used as synchronous digital outputs (marker outputs) when used on an AWG card.

Using the digital expansion module makes a mixed-mode device of any M2p-based digitizer or arbitrary waveform generator. The expansion module is available with two different connection versions: either 16 SMB connectors with 10 of them directly located on the front plate or with a flat-ribbon 40-pole FX2 connector which is pin compatible to all older digital expansion options of Spectrum.

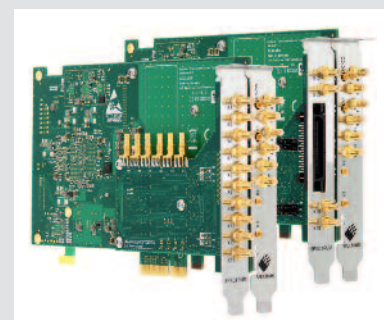

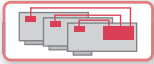

Option Synchronization Star-Hub

The Star-Hub is an additional module allowing the phase stable synchronization of up to 16 boards (M2p series) or up to 8 boards (M4i series). Independent of the number of boards there is no phase delay between all channels. The piggy-back module distributes clock, trigger and control lines to all connected cards and can be ordered in two different mounting positions: as extension module, extending the master board without adding the need for an additional slot space; or as top mount module, keeping the board length the same but needing an additional slot space.

All connected boards are running with the same clock and the same trigger. Each board is internally connected with a small cable of the same length, even the master board. That minimizes the clock skew between the different boards. The clock skew is down to 130 ps between any two cards, depending on the family used.

On the M2p series the Star-Hub allows the synchronization of various cards when running with different sampling rates. This allows a mix of slow and fast sampling as well as the mixing of acquisition cards and generator cards in one system whilst still preserving the phase relation between the different channels



Star-Hub for M4i family

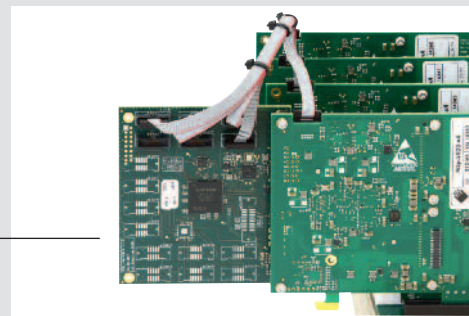

Star-Hub for M2p family



► M4x PXI Express Platform

- PCIe x4 Gen2 Interface
- More than 1.5 GByte/s streaming rate
- 3U double-width card
- PXIe reference clock supported
- PXIe trigger bus and star trigger supported
- SMA and MMCX connections

► Advantages of the PXIe platform

- Industrial systems with robust connections
- Defined clock and trigger interconnection between the cards and the chassis
- Front-side card handles for easy exchange
- Defined air-stream for cooling
- Different chassis sizes from 4 slot up to 21 slot available
- Mix and match components from different vendors

► Outstanding Continuous Streaming Speed

The optimized firmware and kernel driver of the Spectrum PXIe cards allows a sustained streaming speed between card and PC of more than 1.5 GByte/s, reaching 1.7 GByte/s on selected systems. The on-board memory of 4 GByte is completely used as a FIFO buffer.

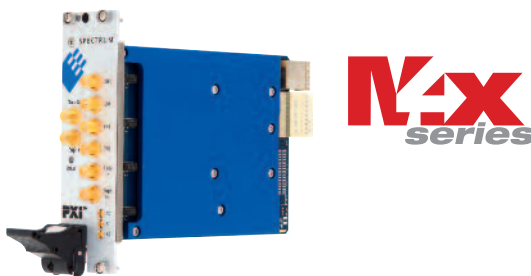

PXI Express or PXIe is a subset of the PXI standard that replaces the parallel data bus of PXI with a high-speed serial interface. PXIe provides the most advantages for modular instruments like digitizers or arbitrary waveform generators which often need to transfer large amounts of data. For example, state-of-the-art PXIe products from Spectrum incorporate a fast interface that can stream at rates of up to 1.7 GByte/s.

digitizer**NETBOX** generator**NETBOX**

The digitizerNETBOX/generatorNETBOX is a remote solution that is connected by Ethernet using the LXI standard. The device can be used as bench-top instrument directly connected to a laptop or desktop PC or as 19" instrument connected to the company LAN and accessible from anywhere.

- Complete portable instrument solution
- Connect directly to your PC or Laptop or anywhere in the company LAN
- BNC (< 125 MS/s) or SMA (> 125 MS/s) connectors
- SBench 6 Professional software license included
- 19" and DC power supply options available

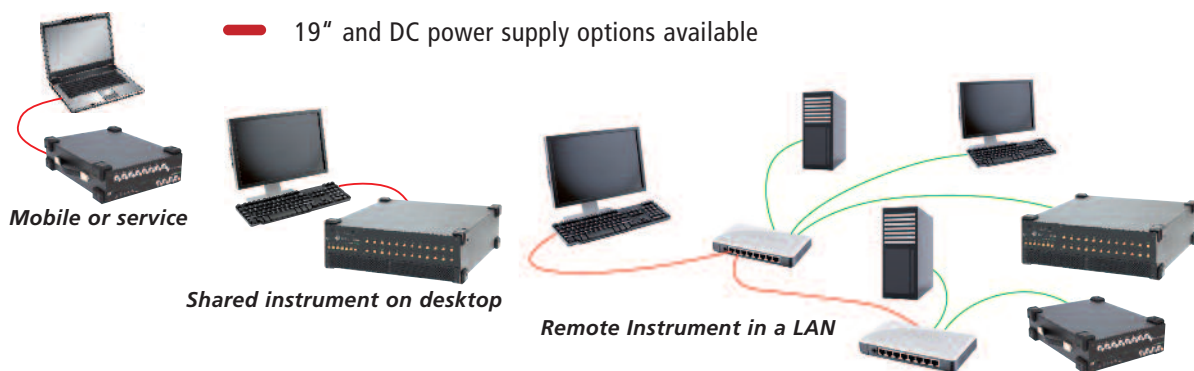

DN2 Series

Small and portable LXI/Ethernet device with up to 16 channels

Up to 16 analog channels with either BNC or SMA connectors. Full analog interface with programmable ranges, termination and offset available



The handle, the stackable bumpers, the light weight of only 6 kg and the optional internal DC power supply make it possible to use the DN2 devices for mobile applications, service jobs or for mechanical integration into custom systems.

Each LXI device from Spectrum offers several interconnections with other instruments. Be it trigger or clock input and output, universal I/O lines or a timestamp reference clock input.



19" rack mount kit available as an option

▶ LXI eXtensions for Instrumentation

The digitizerNETBOX/generatorNETBOX is a fully compliant LXI instrument that is able to show the status of the box along with the current acquisition/generation information. It offers an IVI compatible interface for the IVI digitizer, IVI scope and IVI FGen classes.

LAN eXtensions for Instrumentation (LXI) is a standard developed by the LXI Consortium, an industry consortium that maintains the LXI specification, promotes the LXI Standard, and ensures interoperability. The LXI standard defines the communication protocols for instrumentation and data acquisition systems using Ethernet.



LAN eXtensions for Instrumentation

SB6



SBench 6 – Powerful Data Acquisition and Analysis Software

SBench 6 – The digitizerNETBOX/generatorNETBOX can be used with Spectrum's powerful software SBench 6 – a Professional license for the software is already installed in the box. SBench 6 supports all of the standard features of the instrument (see page 38 for more details).

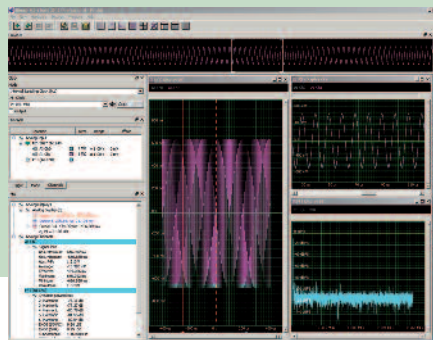

DN6 Series

19" multi-channel LXI/Ethernet systems which can be used either as desktop or rack mount versions. Up to 48 channels in a single chassis.

Up to 48 analog channels with either BNC or SMA connectors. Full analog interface with programmable ranges, termination and offset available



Powerful cooling fans, a replaceable dust filter and the heavy, well-shielded metal chassis make the DN6 a reliable instrument for industry and research environments.

► Embedded Server Option

This option turns the digitizerNETBOX/generatorNETBOX into a powerful PC that can run your own programs on a small and remote data acquisition system. The Ethernet device is enhanced by more memory, a powerful CPU, a freely accessible internal SSD and a remote software development access method.

The enhanced instrument can either run connected to a LAN or it can run totally independently, storing data to the internal SSD. The original remote instrument functionality is fully maintained but running the embedded server option allows the pre-calculation of results inside the unit. Then you can choose to transfer just the information (data or calculated results) that's required in a client-server based software structure. The embedded server option is ideal for surveillance/logger applications, which can run totally independently for days. When necessary, it can send notification emails or alerts over the LAN, or offload stored data as soon as it's connected again.

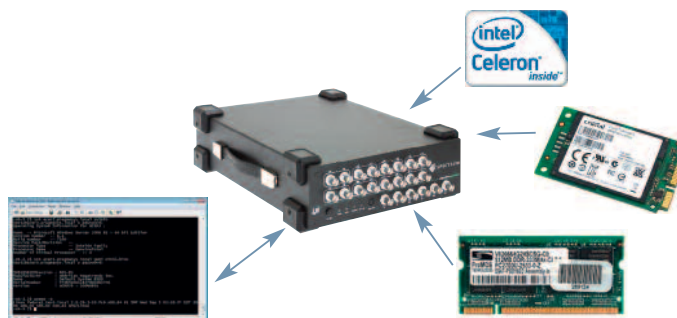

Digitizers

A digitizer is an electronic acquisition device that acquires analog waveforms, processes them through analog-to-digital converters (ADCs) and sends the digitized sample to a buffer, which allows them to be saved before being processed by a computer.

Today's modular digitizers share a common historical architecture augmented by new high speed serial interface standards such a PCI Express (PCIe) and PXI Express (PXIe).

Synchronous Sampling

All digitizers from Spectrum are built with a completely synchronous design. Every channel has its own independent input amplifier as well as an independent A/D converter. All the input channel related settings can be individually programmed. Compared with standard products that use multiplex technology, where scanning of each channel is done one after the other with a single A/D converter, the more sophisticated design of the Spectrum products has a lot of advantages:

- Full sampling rate for all channels
- No phase delay between the single channels
- Smallest crosstalk between adjacent channels due to individual input amplifiers
- Direct comparison of acquired values with no need for interpolation

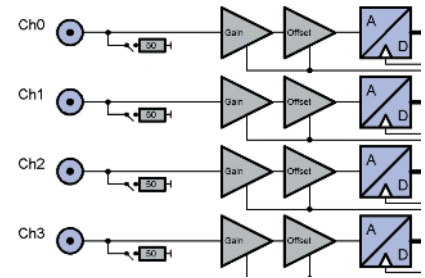

Digitizer Terms

Selecting a digitizer requires matching the application needs to the digitizer specifications. The following is a glossary of common digitizer specifications and terms:

Acquisition Memory

Digital data from the ADCs is stored in a high speed buffer memory called the acquisition memory. The depth of the digitizers acquisition memory determines the length of a signal that may be stored in the buffer before it must be transferred for processing, display or saved. Longer memory also allows for a higher sampling rate over extended record times.

Analog-to-Digital Converter (ADC)

An analog-to-digital converter transforms an analog signal captured by a sampler into digital data that can be processed by a computer.

Resolution

The resolution of an ADC is specified by the number of bits used to represent the analog value, ideally giving 2^N signal levels for an N-bit signal. Resolution is important for measuring large dynamic signals that contain small signal variations.

Sampling Rate

The sampling rate, or sample rate, of a digitizer is the frequency at which analog signals are converted to digital data by the analog-to-digital converter. Effective measurement requires the sample rate of a digitizer to be least twice the frequency of the highest signal frequency component. This is called the Nyquist rate. It is preferable to sample slightly higher than Nyquist.

Bandwidth (-3 dB)

Digitizer bandwidth represents the frequency range that can go through the input stage without significant loss of signal amplitude. Bandwidth is typically measured as the frequency (in Hertz) where the signal amplitude falls to half the power (-3 dB) of the signal at a low frequency.

Dynamic Range

The digitizers dynamic range determines the maximum and minimum signal voltages that can be measured in one acquisition. A large dynamic range allows for the measurement of signals that contain both small and large voltage components at the same time. Dynamic range is related to the digitizers resolution.

Memory Segmentation

Fast, repetitive signals are stored on each trigger event as a single segment within the memory. This reduces the required transfer rate and saves memory.



Transient Capture / Ring Buffer Mode

The standard mode of the digitizer is the ring buffer mode. In this mode data is written into the buffer until a trigger event occurs. After the event additional posttrigger values are recorded enabling both pre- and posttrigger data to be acquired. It is also possible to read the acquired data directly after the trigger event, even while the acquisition is still running.

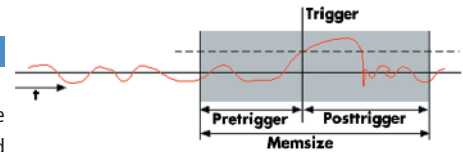

FIFO Mode

The FIFO mode is designed for continuous data transfer between the digitizer and the PC memory or hard disk. It uses the complete on-board memory as a real FIFO buffer, making the transfer extremely reliable. Data is transferred over the bus by the driver without the need for the user to make any special setup. Spectrum products are designed to reach maximum continuous transfer speeds and can reach up to 3.4 GByte/s on a PCIe x8 Gen2 interface.



Multiple Recording

Multiple recording allows the acquisition of several trigger events without restarting the hardware. The on-board memory is split into segments and for each trigger event one segment is recorded. The segment size and the pre- and posttrigger settings can be freely defined. The powerful combination of a small re-arming time and FIFO mode makes it easy to adapt to nearly every measurement task.

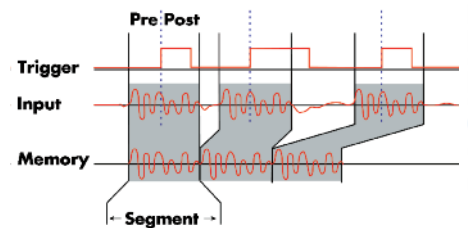

Gated Sampling

With Gated Sampling the acquisition is controlled by an external gate signal. Data is only acquired if the gate signal has reached a programmed level. Before and after each gate a programmable number of samples will be acquired in addition.

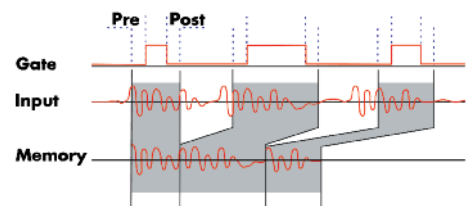

Gated Sampling can be combined with timestamps for time-correct positioning of the gate segments and to determine the length of each acquired gate segment.



ABA Mode / Dual Timebase

The ABA mode is similar to Multiple Recording. However, between the segments additional samples are acquired with a slower sampling rate, e.g. for monitoring purposes. The ABA mode works like the combination of a data logger and transient recorder inside one instrument.

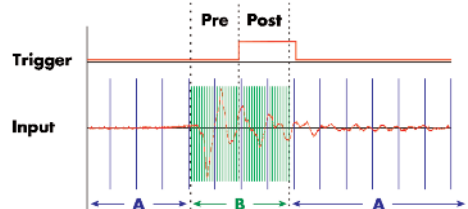

Timestamp

The Timestamp mode writes the time positions of the trigger events into an extra memory. The Timestamps are relative to the start of recording, to a defined zero time or externally synchronized to the seconds signal from a radio clock or a GPS receiver. With this mode acquisitions of systems in different locations may be set in a precise time relation.

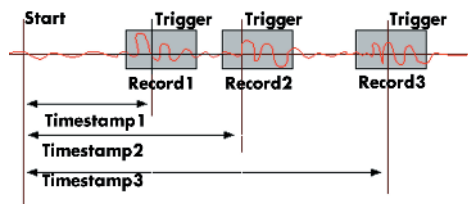

The Timestamp memory is designed as a FIFO buffer allowing the readout of Timestamps also in FIFO mode.



Integrated Signal Processing

All digitizers of 44xx and 22xx series including PCIe, LXI/Ethernet and PXIe versions can be extended by integrated signal processing functions.

The Block Average Processing Module allows the accumulation and averaging of multiple repetitive signals. The function removes random noise from the signal, improving the signal-to-noise ratio and measurement resolution. Ultrafast triggering also ensures the dead-time between each acquisition is kept to a minimum.

The Block Statistics Processing Module is a hardware-based data analysis and reduction function. Each acquisition block is scanned for minimum and maximum peaks and a summary including min, max, average, timestamps and peak position information is stored in memory.

The 44xx series comes with the native Boxcar averaging mode that enhances the high-resolution digitizer and reduces signal noise.

22xx Series – Ultra High-Speed 8 Bit Digitizers up to 5 GS/s

- One, two or four channel PCIe and PXIe card versions
- Two to 24 channel LXI/Ethernet versions
- 50 Ω high bandwidth front-end with 4 input ranges between ±200 mV and ±2.5 V
- Low voltage option: ±40 mV to ±500 mV
- Programmable input offset ±200 %
- 1 to 4 GSample memory per channel
- Firmware options Block Average and Block Statistics available
- 3 multi-purpose I/O lines

STAR-HUB

This piggy-back module synchronizes up to 8 cards of the M4i.22xx-family. Top mount (TM) version with 2 slots width or Extension (EX) version with 1 slots width and 312 mm length are available.

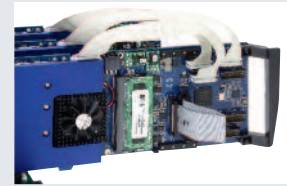

DIGITIZERS

18

**Fastest Digitizer
with 8 Bit
5 GS/s**

M4i
series

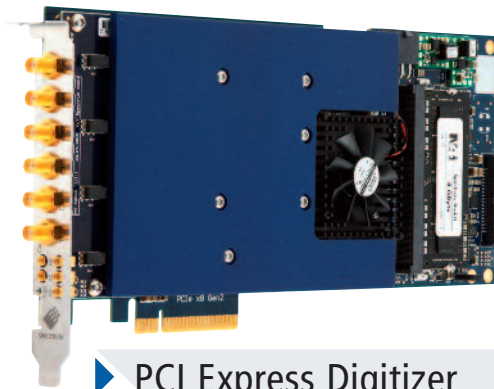

▶ PCI Express Digitizer

- PCIe x8 Gen2 Interface
- up to 3.4 GByte/s streaming rate
- Star-Hub for internal synchronization up to 8 cards
- 243 mm single-slot card
- SMA and MMCX connections
- SCAPP option for CUDA based calculations

M4x
series



▶ PXI Express Digitizer

- PCIe x4 Gen2 Interface
- up to 1.7 GByte/s streaming rate
- 3U double-width card
- PXIe reference clock supported
- PXIe trigger bus and star trigger supported
- SMA and MMCX connections

Sampling Rate	Bandwidth	Resolution	PCI Express Digitizer			PXI Express Digitizer	
			4 Channels	2 Channels	1 Channel	4 Channels	2 Channels
1.25 GS/s	500 MHz	8 Bit	M4i.2212-x8 4 x 1.25 GS/s	M4i.2211-x8 2 x 1.25 GS/s	M4i.2210-x8 1 x 1.25 GS/s	M4x.2212-x4 4 x 1.25 GS/s	M4x.2211-x4 2 x 1.25 GS/s
2.5 GS/s	1.5 GHz	8 Bit		M4i.2221-x8 2 x 2.5 GS/s	M4i.2223-x8 1 x 2.5 GS/s 2 x 1.25 GS/s	M4i.2220-x8 1 x 2.5 GS/s	M4x.2221-x4 2 x 2.5 GS/s
5 GS/s	1.5 GHz	8 Bit	M4i.2234-x8 1 x 5 GS/s 2 x 2.5 GS/s 4 x 1.25 GS/s	M4i.2233-x8 1 x 5 GS/s 2 x 2.5 GS/s	M4i.2230-x8 1 x 5 GS/s	M4x.2234-x4 1 x 5 GS/s 2 x 2.5 GS/s 4 x 1.25 GS/s	

Technical Details

Input Coupling	AC/DC
Input Impedance	50 Ω
Input Ranges (Standard)	±200 mV, ±500 mV, ±1 V, ±2.5 V
Input Ranges (Option)	±40 mV, ±100 mV, ±200 mV, ±500 mV
Input Offset:	±200 % of input range, programmable in 1% steps
SNR (10 MHz signal)	46.9 dB (1.25 GS/s)
	45.6 dB (2.5 GS/s)
	44.5 dB (5 GS/s)
ENOB (10 MHz signal)	7.5 (1.25 GS/s)
	7.3 (2.5 GS/s)
	7.1 (5 GS/s)
RMS Noise	0.2 LSB (1.25 GS/s)
	0.3 LSB (2.5 GS/s)
	0.3 LSB (5 GS/s)
Trigger Modes	Channel, External, Software, Window, Re-Arm, Delay, OR/AND
Acquisition Modes	Single-Shot, FIFO, Multiple Recording, Gated Sampling, ABA Mode, Block Average (Option), Block Statistics (Option), Stream to CUDA-GPU (Option, PCIe only)
External Trigger	2 Inputs, programmable level ±10 V, 200 MHz
Re-Arming Time	80 samples (1.25 GS/s)
	160 samples (2.5 GS/s)
	320 samples (5 GS/s)
Clock Modes	Internal, External Reference
Sampling Clocks	maximum sampling rate + divider: 1, 2, 4, 8, ... 262144
External Reference Clock	10 MHz to 1.25 GHz
External Clock Type	Single-ended, sine or square wave 0.3 V to 3.0 V peak-peak
Multi-Purpose I/O	Input: Synchronous Digital-In, Asynchronous Digital-In, Timestamp Reference Clock Output: Asynchronous Digital-Out, Trigger Out, Status, PLL Reference Clock, System Clock

digitizerNETBOX



Mobile LXI/Ethernet digitizerNETBOX

- GBit Ethernet Interface
- Remote Control
- Up to 100 MByte/s streaming speed
- All connections SMA
- DC power supply option available
- Embedded Server option available

19" LXI/Ethernet digitizerNETBOX

- GBit Ethernet Interface
- Remote Control
- Up to 100 MByte/s streaming speed
- All connections SMA
- Embedded Server option available

2 Channels	1 Channel	8 Channels	4 Channels	2 Channels	24 Channels	20 Channels	16 Channels	12 Channels
	M4x.2210-x4 1 x 1.25 GS/s	DN2.221-08 8 x 1.25 GS/s	DN2.221-04 4 x 1.25 GS/s	DN2.221-02 2 x 1.25 GS/s	DN6.221-24 24 x 1.25 GS/s	DN6.221-20 20 x 1.25 GS/s	DN6.221-16 16 x 1.25 GS/s	DN6.221-12 12 x 1.25 GS/s
M4x.2223-x4 1 x 2.5 GS/s 2 x 1.25 GS/s	M4x.2220-x4 1 x 2.5 GS/s		DN2.222-04 4 x 2.5 GS/s	DN2.222-02 2 x 2.5 GS/s				
M4x.2233-x4 1 x 5 GS/s 2 x 2.5 GS/s	M4x.2230-x4 1 x 5 GS/s	DN2.225-08 2 x 5 GS/s 4 x 2.5 GS/s 8 x 1.25 GS/s	DN2.225-04 1 x 5 GS/s 2 x 2.5 GS/s 4 x 1.25 GS/s	DN2.223-02 2 x 5 GS/s	DN6.225-24 6 x 5 GS/s 12 x 2.5 GS/s 24 x 1.25 GS/s	DN6.225-20 5 x 5 GS/s 10 x 2.5 GS/s 20 x 1.25 GS/s	DN6.225-16 4 x 5 GS/s 8 x 2.5 GS/s 16 x 1.25 GS/s	DN6.225-12 3 x 5 GS/s 6 x 2.5 GS/s 12 x 1.25 GS/s

Dual-Use listed products with the need of an export license when exporting outside Europe/US/Canada

44xx Series – High-Resolution High-Speed Digitizers up to 500 MS/s ...

- One, two or four channel PCIe and PXIe card versions
- Two to 24 channel LXI/Ethernet versions
- 50 Ω/1 MΩ front-end with 6 input ranges between ±200 mV and ±10 V
- Input ranges switchable between bipolar and unipolar
- 512 MSamples to 2 GSamples memory per channel
- Boxcar Average (high-resolution) mode to increase resolution
- Firmware options Block Average and Block Statistics available
- 3 multi-purpose I/O lines

STAR-HUB

This piggy-back module synchronizes up to 8 cards of the M4i.44xx-family. Top mount (TM) version with 2 slots width or Extension (EX) version with 1 slots width and 312 mm length are available.

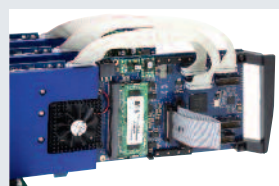

DIGITIZERS

Fastest 14 Bit Digitizer with 500 MS/s



M4i
series

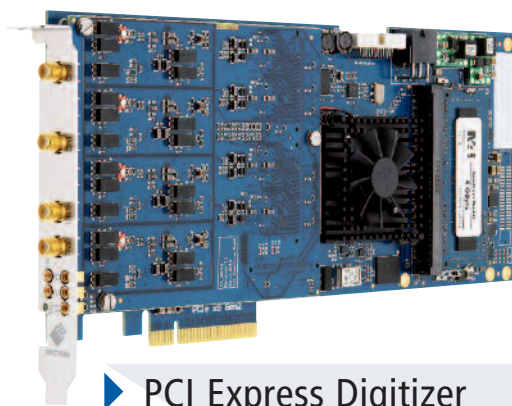

▶ PCI Express Digitizer

- PCIe x8 Gen2 Interface
- up to 3.4 GByte/s streaming rate
- Star-Hub for internal synchronization up to 8 cards
- 243 mm single-slot card
- SMA and MMCX connections
- SCAPP option for CUDA-based calculations

M4x
series



▶ PXI Express Digitizer

- PCIe x4 Gen2 Interface
- up to 1.7 GByte/s streaming rate
- 3U double-width card
- PXIe reference clock supported
- PXIe trigger bus and star trigger supported
- SMA and MMCX connections

Sampling Rate	Bandwidth	Resolution	M4i series		M4x series	
			4 Channels	2 Channels	4 Channels	2 Channels
180 MS/s	125 MHz (HF)	16 Bit	M4i.4471-x8	M4i.4470-x8	M4x.4471-x4	M4x.4470-x4
	85 MHz (Buffered)		4 x 180 MS/s	2 x 180 MS/s	4 x 180 MS/s	2 x 180 MS/s
250 MS/s	125 MHz (HF)	16 Bit	M4i.4421-x8	M4i.4420-x8	M4x.4421-x4	M4x.4420-x4
	85 MHz (Buffered)		4 x 250 MS/s	2 x 250 MS/s	4 x 250 MS/s	2 x 250 MS/s
400 MS/s	250 MHz (HF)	14 Bit	M4i.4481-x8	M4i.4480-x8	M4x.4481-x4	M4x.4480-x4
	125 MHz (Buffered)		4 x 400 MS/s	2 x 400 MS/s	4 x 400 MS/s	2 x 400 MS/s
500 MS/s	250 MHz (HF)	14 Bit	M4i.4451-x8	M4i.4450-x8	M4x.4451-x4	M4x.4450-x4
	125 MHz (Buffered)		4 x 500 MS/s	2 x 500 MS/s	4 x 500 MS/s	2 x 500 MS/s

Technical Details

Input Coupling	AC/DC
Input Impedance	50 Ω (HF Path) / 1 MΩ (Buffered Path)
Input Ranges (HF Path)	±500 mV, ±1 V, ±2.5 V, ±5 V
Input Ranges (Buffered)	±200 mV, ±500 mV, ±1 V, ±2 V, ±5 V, ±10 V
SNR (10 MHz signal)	67.8 dB (500 MS/s, 400 MS/s)
	71.5 dB (250 MS/s, 180 MS/s)
	71.8 dB (130 MS/s)
ENOB (10 MHz signal)	11.0 (500 MS/s, 400 MS/s)
	11.6 (250 MS/s, 180 MS/s)
	11.6 (130 MS/s)
RMS Noise (HF Path)	1.9 LSB (500 MS/s, 400 MS/s)
	6.9 LSB (250 MS/s, 180 MS/s)
	5.9 LSB (130 MS/s)
Trigger Modes	Channel, External, Software, Window, Re-Arm, Delay, OR/AND
Acquisition Modes	Single-Shot, FIFO, Multiple Recording, Gated Sampling, ABA Mode, Boxcar-Average, Block Average (Option), Block Statistics (Option), Stream to CUDA-GPU (Option, PCIe only)
External Trigger	2 Inputs, programmable level ±10 V, 200 MHz
Re-Arming Time	40 samples
Clock Modes	Internal + Divider, Internal Special Clock, External Reference
Special Clock Granularity	1 Hz
External Reference Clock	10 MHz to 1.0 GHz
External Clock Type	Single-ended, sine or square wave 0.3 V to 3.0 V peak-peak
Multi-Purpose I/O	Input: Synchronous Digital-In, Asynchronous Digital-In, Timestamp Reference Clock Output: Asynchronous Digital-Out, Trigger Out, Status, PLL Reference Clock, System Clock

digitizerNETBOX



▶ Mobile LXI/Ethernet digitizerNETBOX

- GBit Ethernet Interface
- Remote Control
- Up to 100 MByte/s streaming speed
- All connections SMA
- DC power supply option available
- Embedded Server option available

▶ 19" LXI/Ethernet digitizerNETBOX

- GBit Ethernet Interface
- Remote Control
- Up to 100 MByte/s streaming speed
- All connections SMA
- Embedded Server option available

Mobile LXI/Ethernet digitizerNETBOX			19" LXI/Ethernet digitizerNETBOX			
8 Channels	4 Channels	2 Channels	24 Channels	20 Channels	16 Channels	12 Channels
DN2.447-08 8 x 180 MS/s	DN2.447-04 4 x 180 MS/s	DN2.447-02 2 x 180 MS/s	DN6.447-24 24 x 180 MS/s	DN6.447-20 20 x 180 MS/s	DN6.447-16 16 x 180 MS/s	DN6.447-12 12 x 180 MS/s
DN2.442-08 8 x 250 MS/s	DN2.442-04 4 x 250 MS/s	DN2.442-02 2 x 250 MS/s	DN6.442-24 24 x 250 MS/s	DN6.442-20 20 x 250 MS/s	DN6.442-16 16 x 250 MS/s	DN6.442-12 12 x 250 MS/s
DN2.448-08 8 x 400 MS/s	DN2.448-04 4 x 400 MS/s	DN2.448-02 2 x 400 MS/s	DN6.448-24 24 x 400 MS/s	DN6.448-20 20 x 400 MS/s	DN6.448-16 16 x 400 MS/s	DN6.448-12 12 x 400 MS/s
DN2.445-08 8 x 500 MS/s	DN2.445-04 4 x 500 MS/s	DN2.445-02 2 x 500 MS/s	DN6.445-24 24 x 500 MS/s	DN6.445-20 20 x 500 MS/s	DN6.445-16 16 x 500 MS/s	DN6.445-12 12 x 500 MS/s

Dual-Use listed products with the need of an export license when exporting outside Europe/US/Canada

59xx Series – 16 Bit General Purpose Digitizers up to 125 MS/s

- One, two, four or eight channel PCIe card versions
- Four to 48 channel LXI/Ethernet versions
- Inputs switchable between single-ended and differential
- 50 Ω/1 MΩ front-end with 6 input ranges between ±200 mV and ±10 V
- Input ranges switchable between bipolar and unipolar
- 64 MSamples to 512 MSamples memory per channel
- 20 (4 standard + 16 as option) multi-purpose I/O

STAR-HUB

This piggy-back module synchronizes multiple cards of the whole M2p-family (digitizers and AWGs). The star-hub is available for 6 cards or 16 cards and can either be ordered as top mount (TM) version with two slots width or as Extension (EX) version with 1 slot width and 245 mm length.



DIGITAL OPTION

This piggy-back module adds 16 additional digital lines to the 4 multi-purpose I/O lines that are already standard on the cards. It allows to run a single 59xx card as mixed mode device with 8 analog channels and 19 synchronous digital channels. The module is available in two different versions, one with SMB connectors and one with an FX2 flat-ribbon connector.



DIGITIZERS

Single-Ended and True Differential Inputs

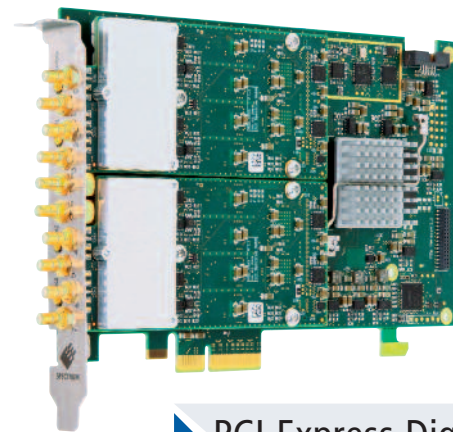

M2p
series

▶ PCI Express Digitizer

- PCIe x4 Gen1 Interface
- more than 700 MByte/s streaming rate
- Star-Hub for internal synchronization up to 16 cards
- ½ length single slot PCIe card
- SMB and MMCX connections
- SCAPP option for CUDA-based calculations

Sampling Rate	Bandwidth	Resolution
5 MS/s	2.5 MHz	16 Bit
20 MS/s	10 MHz	16 Bit
40 MS/s	20 MHz	16 Bit
80 MS/s	40 MHz	16 Bit
125 MS/s	50 MHz	16 Bit

8 Channels	4 Channels	2 Channels	1 Channel
M2p.5913-x4 8 x 5 MS/s SE 4 x 5 MS/s Diff	M2p.5916-x4 4 x 5 MS/s SE 4 x 5 MS/s Diff	M2p.5912-x4 4 x 5 MS/s SE 2 x 5 MS/s Diff	M2p.5911-x4 2 x 5 MS/s SE 2 x 5 MS/s Diff
M2p.5923-x4 8 x 20 MS/s SE 4 x 20 MS/s Diff	M2p.5926-x4 4 x 20 MS/s SE 4 x 20 MS/s Diff	M2p.5922-x4 4 x 20 MS/s SE 2 x 20 MS/s Diff	M2p.5921-x4 2 x 20 MS/s SE 2 x 20 MS/s Diff
M2p.5933-x4 8 x 40 MS/s SE 4 x 40 MS/s Diff	M2p.5936-x4 4 x 40 MS/s SE 4 x 40 MS/s Diff	M2p.5932-x4 4 x 40 MS/s SE 2 x 40 MS/s Diff	M2p.5931-x4 2 x 40 MS/s SE 2 x 40 MS/s Diff
M2p.5943-x4 8 x 80 MS/s SE 4 x 80 MS/s Diff	M2p.5946-x4 4 x 80 MS/s SE 4 x 80 MS/s Diff	M2p.5942-x4 4 x 80 MS/s SE 2 x 80 MS/s Diff	M2p.5941-x4 2 x 80 MS/s SE 2 x 80 MS/s Diff
M2p.5968-x4 4 x 125 MS/s SE 4 x 125 MS/s Diff 8 x 80 MS/s SE	M2p.5966-x4 4 x 125 MS/s SE 4 x 125 MS/s Diff	M2p.5962-x4 4 x 125 MS/s SE 2 x 125 MS/s Diff	M2p.5961-x4 2 x 125 MS/s SE 2 x 125 MS/s Diff

SE = Single-Ended Inputs
Diff = Differential Inputs (non-isolated)

Technical Details

Input Type	Single-Ended or True Differential (non-isolated)				
Input Impedance	50 Ω/1 MΩ				
Input Ranges	±200 mV, ±500 mV, ±1 V, ±2 V, ±5 V, ±10 V				
Input Offset (single-ended)	±100%				
	591x (5 MS/s)	592x (20 MS/s)	593x (40 MS/s)	594x (80 MS/s)	596x (125 MS/s)
SNR (1 MHz signal)	86.0 dB	81.0 dB	75.3 dB	74.2 dB	73.3 dB
ENOB (1 MHz signal)	14.0 LSB	13.2 LSB	12.2 LSB	12.0 LSB	11.8 LSB
Trigger Modes	Channel, External, Software, Window, Re-Arm, Delay, OR/AND, Pulse, Hold-off				
Acquisition Modes	Single-Shot, FIFO, Multiple Recording, Gated Sampling, ABA Mode, Stream to CUDA-GPU (Option, PCIe only)				
External Trigger	1 with programmable level ±5 V, 3 additional LVTTL				
Clock Modes	Internal, Direct External Clock, External Reference Clock				
Sampling Clocks	1 kS/s up to maximum sampling clock				
External Reference Clock	128 kHz to 125 MHz				
External Clock Type	Single-ended, sine or square wave with programmable level ±5 V				
Multi-Purpose I/O	Input: Synchronous Digital-In, Asynchronous Digital-In, Timestamp Reference Clock, Trigger Output: Asynchronous Digital-Out, Trigger Out, Status, ADC Clock				

digitizerNETBOX



▶ Mobile LXI/Ethernet digitizerNETBOX

- GBit Ethernet Interface
- Remote Control
- Up to 100 MByte/s streaming speed
- All connections BNC
- DC power supply option available
- Embedded Server option available

▶ 19" LXI/Ethernet digitizerNETBOX

- GBit Ethernet Interface
- Remote Control
- Up to 100 MByte/s streaming speed
- All connections BNC
- Embedded Server option available

16 Channels	8 Channels	4 Channels
DN2.591-16 16 x 5 MS/s SE 8 x 5 MS/s Diff	DN2.591-08 8 x 5 MS/s SE 4 x 5 MS/s Diff	DN2.591-04 4 x 5 MS/s SE 4 x 5 MS/s Diff
DN2.592-16 16 x 20 MS/s SE 8 x 20 MS/s Diff	DN2.592-08 8 x 20 MS/s SE 4 x 20 MS/s Diff	DN2.592-04 4 x 20 MS/s SE 4 x 20 MS/s Diff
DN2.593-16 16 x 40 MS/s SE 8 x 40 MS/s Diff	DN2.593-08 8 x 40 MS/s SE 4 x 40 MS/s Diff	DN2.593-04 4 x 40 MS/s SE 4 x 40 MS/s Diff
DN2.596-16 8 x 125 MS/s SE 8 x 125 MS/s Diff 16 x 80 MS/s SE	DN2.596-08 4 x 125 MS/s SE 4 x 125 MS/s Diff 8 x 80 MS/s SE	DN2.596-04 4 x 125 MS/s SE 4 x 125 MS/s Diff 4 x 125 MS/s Diff

48 Channels	40 Channels	32 Channels	24 Channels
DN6.591-48 48 x 5 MS/s SE 24 x 5 MS/s Diff	DN6.591-40 40 x 5 MS/s SE 20 x 5 MS/s Diff	DN6.591-32 32 x 5 MS/s SE 16 x 5 MS/s Diff	DN6.591-24 24 x 5 MS/s SE 12 x 5 MS/s Diff
DN6.592-48 48 x 20 MS/s SE 24 x 20 MS/s Diff	DN6.592-40 40 x 20 MS/s SE 20 x 20 MS/s Diff	DN6.592-32 32 x 20 MS/s SE 16 x 20 MS/s Diff	DN6.592-24 24 x 20 MS/s SE 12 x 20 MS/s Diff
DN6.593-48 48 x 40 MS/s SE 24 x 40 MS/s Diff	DN6.593-40 40 x 40 MS/s SE 20 x 40 MS/s Diff	DN6.593-32 32 x 40 MS/s SE 16 x 40 MS/s Diff	DN6.593-24 24 x 40 MS/s SE 12 x 40 MS/s Diff
DN6.596-48 24 x 125 MS/s SE 24 x 125 MS/s Diff 48 x 80 MS/s Diff	DN6.596-40 20 x 125 MS/s SE 20 x 125 MS/s Diff 40 x 80 MS/s SE	DN6.596-32 16 x 125 MS/s SE 16 x 125 MS/s Diff 32 x 80 MS/s SE	DN6.596-24 12 x 125 MS/s SE 12 x 125 MS/s Diff 24 x 80 MS/s SE

Arbitrary Waveform Generators

Electronic test and measurements equipment can be classified into two major categories; measurement instruments and signal sources. Instruments such as digital multi-meters, digitizers, oscilloscopes, spectrum analyzers, and logic analyzers measure electrical characteristics of an input signal, most typically electrical potential difference or voltage. Signal sources, such as Arbitrary Waveform Generators (AWGs), are often required to provide a test stimulus, where the devices being tested do not generate signals on their own.

Arbitrary waveform generators (AWGs) are analog signal sources that operate very much like a digitizer in reverse. Where a digitizer samples an analog waveform, digitizes it and then stores it in its acquisition memory, the AWG has a numeric description of the waveform stored in waveform memory. Selected samples of the waveform are sent to a digital to analog converter (DAC) and then, with appropriate filtering and signal conditioning, are output as an analog waveform.

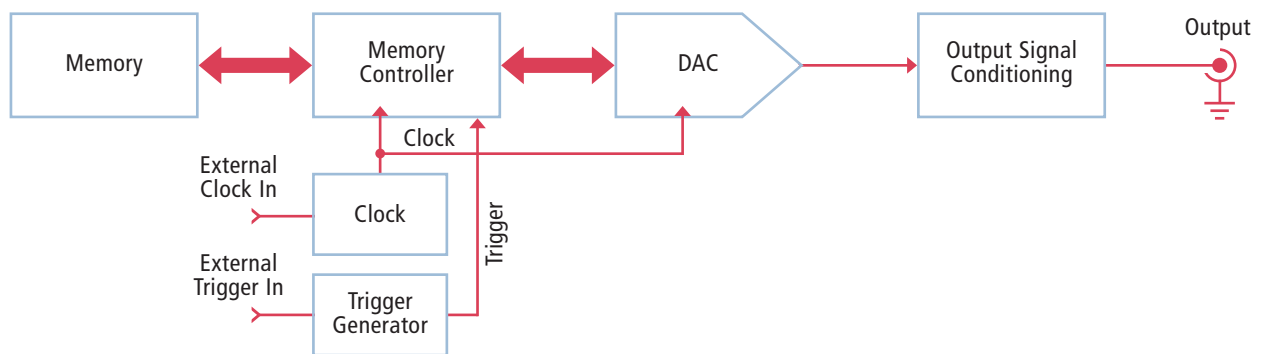

Arbitrary Waveform Generator Terms

The specifications for an arbitrary waveform generator are quite different from standard signal generators. That is due to the great flexibility in the output waveform selection and the digital nature of the AWG.

Bandwidth, Sampling Rate and Maximum Output Frequency

The key parameters, like with digitizers, are bandwidth and sampling rate. The bandwidth determines the highest sine wave frequency that the AWG can output with a loss less than 3 dB. Since many of the waveforms that can be created by the AWG are harmonic rich the bandwidth limit will determine the highest frequency waveform which can be generated. For example, a square wave generally has to be able to pass the fifth harmonic to be recognizable. For a given bandwidth the highest frequency square wave is one fifth the AWG bandwidth.

The sampling rate is related to the bandwidth. According to sampling theory the sampling rate has to be at least twice the bandwidth. With a fixed maximum bandwidth increasing the sampling rate does not improve the maximum bandwidth. The sampling rate also determines the horizontal resolution of the AWG. This defines the smallest time increment that can be set within the waveforms.

Memory Depth

The size of the waveform memory determines the longest waveform that can be output without repeating (looping) any waveform components. The limit of signal duration, without looping, is memory length times the sample period. The use of looping to repeat redundant waveform components without taking any extra memory space can greatly increase the maximum waveform length.

Modular AWGs with First-In First-Out (FIFO) streaming mode can further extend waveforms by utilizing the memory of their host computer. For example, the Spectrum M4i.66xx series products can stream data at speeds of up to 2.8 GBytes/s from the host PC to the AWG using the AWG's internal memory as a high-speed buffer. This frees the AWG from the memory limits of the internal memory. Combining FIFO streaming with looping and linking functions enables the generation of an unprecedented variety of long waveforms.

Amplitude Resolution

Amplitude resolution specifies the minimum output signal level the AWG can generate and the minimum amplitude step between adjacent samples. The amplitude resolution of the AWG is determined by the number of bits of the DAC. In general, there is a trade-off between DAC resolution and sampling rate. That is the greater the number of bits in the DAC the lower the maximum sampling rate.

AWGs may incorporate multiple operating modes which determine how the stored waveforms are replayed. The ability to repeat (loop) selected segments of the waveform and advance between segments based on triggers or gating signals provides the ultimate flexibility and reduces the amount of memory required for complex waveforms. Here is a summary of common operating modes:

Singleshot

The programmed waveform is played once after receiving a trigger event be it external or software. After the first trigger subsequent triggers are ignored.

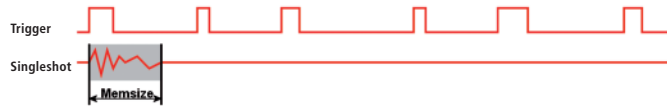

Repeated Output

The programmed waveform is played continuously for a pre-programmed number of times or until a stop command is executed. The trigger source can be either an external trigger inputs or the software trigger. After the first trigger additional trigger events are ignored.

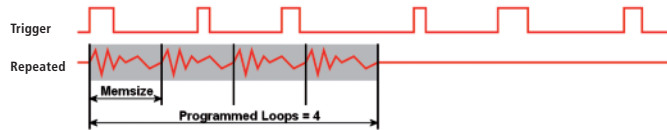

Single Restart Replay

This mode outputs the waveform data of the on-board memory once after each trigger event. The trigger source can be either an external trigger or the internal software trigger.

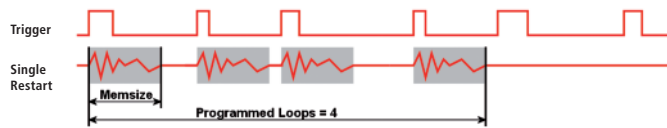

FIFO

The FIFO mode is an operating mode unique to Spectrum's modular AWGs. It is designed for continuous data transfer between the host computers memory or hard disk and the AWG. The complete installed on-board memory is used for buffering data, making the continuous streaming extremely reliable.



Multiple Replay

The Multiple Replay mode provides fast output of waveforms on multiple trigger events without restarting the hardware. The on-board memory is divided into several equal size segments that can contain different waveform data. This mode allows very fast repetition rates.

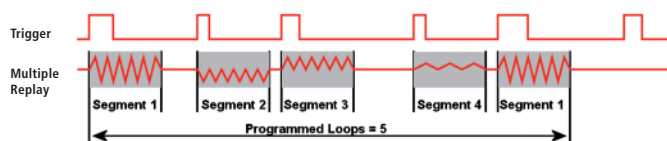

Gated Replay

The Gated Replay sampling mode outputs waveform data controlled by an external gate signal. Data is only replayed if the gate signal is at a pre-programmed level.

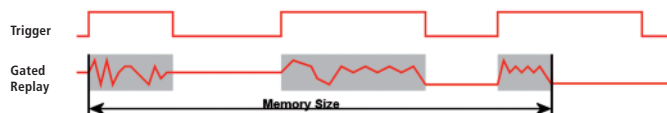

Sequence Replay Mode

The sequence mode splits the internal card memory into a number of data segments of different lengths. These data segments are chained in a user set order using an additional sequence memory. The sequence memory determines the order that segments are output as well as the number of loops for each segment. Trigger conditions can be defined to advance from segment to segment. Using sequence mode it is possible to switch between replay waveforms by a simple software command or to redefine waveform data for segments simultaneously while other segments are being replayed.

66xx Series – 16 Bit High-Speed Arbitrary Waveform Generators up

ARBITRARY WAVEFORM GENERATORS

- One, two or four channel PCIe and PXIe card versions
- Two to 24 channel LXI/Ethernet versions
- Output level up to ± 2.5 V into 50 Ω
- Bandwidth up to 400 MHz (600 MHz as option)
- Fixed trigger to output delay
- 512 MSamples to 2 GSamples memory per channel
- Fast FIFO streaming mode included
- Sequence Replay mode
- 3 multi-purpose I/O lines

Fastest AWG
with 16 Bit
1.25 GS/s

STAR-HUB

This piggy-back module synchronizes up to 8 cards of the M4i.66xx-family. Top mount (TM) version with 2 slots width or Extension (EX) version with 1 slots width and 312 mm length are available.



M4i
series

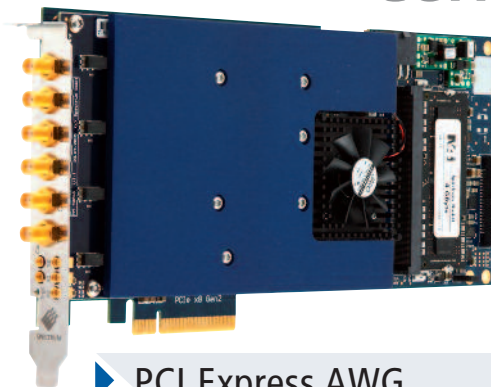

PCI Express AWG

- PCIe x8 Gen2 Interface
- up to 2.8 GByte/s streaming rate
- Star-Hub for internal synchronization up to 8 cards
- 243 mm single-slot card
- SMA and MMCX connections
- SCAPP option for CUDA-based data generation

M4x
series

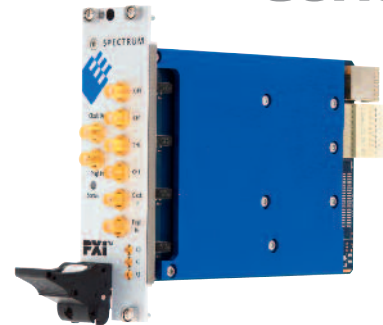

PXI Express AWG

- PCIe x4 Gen2 Interface
- up to 1.4 GByte/s streaming rate
- 3U double-width card
- PXIe reference clock supported
- PXIe trigger bus and star-trigger supported
- SMA and MMCX connections

Sampling Rate	Bandwidth	Output Level	Resolution
625 MS/s	200 MHz	± 2.5 V	16 Bit
1.25 GS/s	400 MHz 320 MHz	± 480 mV ± 2.0 V	16 Bit

4 Channels	2 Channels	1 Channel
M4i.6622-x8 4 x 625 MS/s	M4i.6621-x8 2 x 625 MS/s	M4i.6620-x8 1 x 625 MS/s
	M4i.6631-x8 2 x 1.25 GS/s	M4i.6630-x8 1 x 1.25 GS/s

4 Channels	2 Channels	1 Channel
M4x.6622-x4 4 x 625 MS/s	M4x.6621-x4 2 x 625 MS/s	M4x.6620-x4 1 x 625 MS/s
	M4x.6631-x4 2 x 1.25 GS/s	M4x.6630-x4 1 x 1.25 GS/s

to 1.25 GS/s

Technical Details

DAC Type	16 Bit, non-interpolating
Output Impedance	50 Ω
Output Level in 50 Ω	±2.5 V (625 MS/s) ±2.0 V (1.25 GS/s)
Marker Outputs	3 free programmable 1 loop marker
SNR (10 MHz signal)	72.1 dB (1.25 GS/s, ±1 V) 72.4 dB (625 MS/s, ±1 V)
ENOB (10 MHz signal)	11.5 dB (1.25 GS/s, ±1 V) 11.7 dB (625 MS/s, ±1 V)
NSD	-149 dBm/Hz (1.25 GS/s, ±1 V) -149 dBm/Hz (625 MS/s, ±1 V)
Trigger Modes	External, Software, Window, Re-Arm, Delay, OR/AND
Replay Modes	Single-Shot, FIFO, Multiple Replay, Gated Replay, Sequence Replay Mode, Stream from CUDA-GPU (Option, PCIe only)
External Trigger	2 Inputs, programmable level ±10 V
Sequence Replay Mode	Up to 4k sequence steps Up to 64k segments Up to 1M loops Loop until Trigger Data and sequence steps overload at runtime
Trigger to Output Delay	238.5 Sample Clocks + 16 ns (625 MS/s) 476.5 Sample Clocks + 16 ns (1.25 GS/s)
Clock Modes	Internal, External Reference Clock
External Reference Clock	10 MHz to 1.25 GHz
External Clock Type	Single-ended, sine or square wave 0.3 V to 3.0 V peak-peak
Multi-Purpose I/O	Input: Asynchronous Digital-In Output: Marker, Synchronous Digital-Out, Asynchronous Digital-Out, Trigger Out, Status, System Clock

ARBITRARY WAVEFORM GENERATORS

27

generatorNETBOX



Mobile LXI/Ethernet generatorNETBOX

- GBit Ethernet Interface
- Remote Control
- Up to 100 MByte/s streaming speed
- All connections SMA
- DC power supply option available
- Embedded Server option available

19" LXI/Ethernet generatorNETBOX

- GBit Ethernet Interface
- Remote Control
- Up to 100 MByte/s streaming speed
- All connections SMA
- Embedded Server option available

8 Channels	4 Channels	2 Channels	24 Channels	20 Channels	16 Channels	12 Channels	10 Channels	8 Channels	6 Channels
DN2.662-08 8 x 625 MS/s	DN2.662-04 4 x 625 MS/s	DN2.662-02 2 x 625 MS/s	DN6.662-24 24 x 625 MS/s	DN6.662-20 20 x 625 MS/s	DN6.662-16 16 x 625 MS/s	DN6.662-12 12 x 625 MS/s			
	DN2.663-04 4 x 1.25 GS/s	DN2.663-02 2 x 1.25 GS/s				DN6.663-12 12 x 1.25 GS/s	DN6.663-10 10 x 1.25 GS/s	DN6.663-08 8 x 1.25 GS/s	DN6.663-06 6 x 1.25 GS/s

65xx Series – 16 Bit Arbitrary Waveform Generators up to 125 MS/s ...

- One, two, four or eight channel PCIe card versions
- Four to 48 channel LXI/Ethernet versions
- Four software-selectable analog filters per channel
- Output level up to ± 3 V into 50Ω
(± 6 V into high-impedance)
- High-voltage version with output level up to ± 6 V
into 50Ω (± 12 V into high-impedance)
- Fixed trigger to output delay
- 64 MSamples up to 512 MSamples memory per channel
- Fast FIFO streaming mode included
- Sequence Replay mode
- 20 (4 standard +16 as option) multi-purpose I/O



8-channel-versions and high-voltage versions occupy 2 slots width

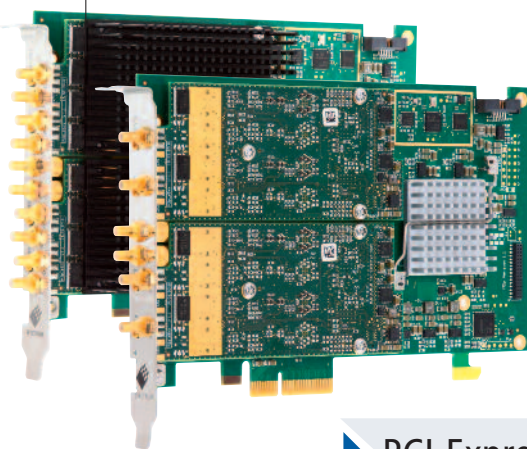

STAR-HUB

This piggy-back module synchronizes multiple cards of the whole M2p-family (digitizers and AWGs). The star-hub is available for 6 cards or 16 cards and can either be ordered as top mount (TM) version with two slots width or as Extension (EX) version with 1 slot width and 245 mm length.



DIGITAL OPTION

This piggy-back module adds 16 additional digital lines to the 4 multi-purpose I/O lines that are already standard on the cards. It allows to run a single 65xx card as mixed mode device with 8 analog channels and 20 synchronous digital channels. The module is available in two different versions, one with SMB connectors and one with an FX2 flat-ribbon connector.



► PCI Express AWG

- PCIe x4 Gen1 Interface
- up to 700 MByte/s streaming rate
- Star-Hub for internal synchronization up to 16 cards
- 168 mm (half-length) card
- SMB and MMCX connections
- SCAPP option for CUDA-based data generation

Sampling Rate	Bandwidth	Output Level	Resolution
40 MS/s	70 MHz	± 3 V (± 6 V)	16 Bit
40 MS/s	70 MHz	± 6 V (± 12 V)	16 Bit
125 MS/s	70 MHz	± 3 V (± 6 V)	16 Bit
125 MS/s	70 MHz	± 6 V (± 12 V)	16 Bit

8 Channels	4 Channels	2 Channels	1 Channel
M2p.6533-x4 8 x 40 MS/s	M2p.6536-x4 4 x 40 MS/s	M2p.6531-x4 2 x 40 MS/s	M2p.6530-x4 1 x 40 MS/s
	M2p.6546-x4 4 x 40 MS/s	M2p.6541-x4 2 x 40 MS/s	M2p.6540-x4 1 x 40 MS/s
M2p.6568-x4 8 x 80 MS/s 4 x 125 MS/s	M2p.6566-x4 4 x 125 MS/s	M2p.6561-x4 2 x 125 MS/s	M2p.6560-x4 1 x 125 MS/s
	M2p.6576-x4 4 x 125 MS/s	M2p.6571-x4 2 x 125 MS/s	M2p.6570-x4 1 x 125 MS/s

Technical Details

DAC Type	16 Bit, non-interpolating
Output Impedance	50 Ω
Output Level Standard	±3 V into 50 Ω (±6 V into high-impedance)
Output Level High Voltage	±6 V into 50 Ω (±12 V into high-impedance)
Marker Outputs	4 (+16 as option) free programmable 1 loop marker
SNR (800 kHz signal)	91 dB (±900 mV)
ENOB (800 kHz signal)	14.7 Bit
NSD	-142 dBm/Hz (±900 mV)
Trigger Modes	External, Software, Pulse, OR/AND, Delay, Holdoff
Replay Modes	Single-Shot, FIFO, Multiple Replay, Gated Replay, Sequence Replay Mode, Stream from CUDA-GPU (Option, PCIe only)
External Trigger	1 with programmable level ±5 V, 3 additional LVTTL
Sequence Replay Mode	Up to 4k sequence steps Up to 64k segments Up to 1M loops Loop until Trigger Data and sequence steps overload at runtime
Trigger to Output Delay	63 sample clocks + 7 ns
Clock Modes	Internal, Direct External Clock, External Reference Clock
Sampling Clocks	1 kS/s up to maximum sampling clock
External Reference Clock	128 kHz to 125 MHz
External Clock Type	Single-ended, sine or square wave with programmable level ±5 V
Multi-Purpose I/O	Input: Asynchronous Digital-In, Logic-Trigger Output: Marker, Synchronous Digital-Out, Asynchronous Digital-Out, Trigger-Out, Status, DAC Clock

generatorNETBOX



▶ Mobile LXI/Ethernet generatorNETBOX

- GBit Ethernet Interface
- Remote Control
- Up to 100 MByte/s streaming speed
- All connections BNC
- DC power supply option available
- Embedded Server option available

▶ 19" LXI/Ethernet generatorNETBOX

- GBit Ethernet Interface
- Remote Control
- Up to 100 MByte/s streaming speed
- All connections BNC
- Embedded Server option available

16 Channels	8 Channels	4 Channels
DN2.653-16 16 x 40 MS/s	DN2.653-08 8 x 40 MS/s	DN2.653-04 4 x 40 MS/s
	DN2.654-08 8 x 40 MS/s	DN2.654-04 4 x 40 MS/s
DN2.656-16 16 x 80 MS/s 8 x 125 MS/s	DN2.656-08 8 x 80 MS/s 4 x 125 MS/s	DN2.656-04 4 x 125 MS/s
	DN2.657-08 8 x 125 MS/s	DN2.657-04 4 x 125 MS/s

48 Channels	40 Channels	32 Channels	24 Channels
DN6.653-48 48 x 40 MS/s	DN6.653-40 40 x 40 MS/s	DN6.653-32 32 x 40 MS/s	DN6.653-24 24 x 40 MS/s
DN6.656-48 48 x 80 MS/s 24 x 125 MS/s	DN6.656-40 40 x 80 MS/s 20 x 125 MS/s	DN6.656-32 32 x 80 MS/s 16 x 125 MS/s	DN6.656-24 24 x 80 MS/s 12 x 125 MS/s

Digital Data Acquisition

Digital data acquisition cards are focused on digital signals. Input signals have two logic levels called low state (0) and high state (1). The electrical representation of these logical levels depends on the logic family and the supported I/O standard.

Digital Data Acquisition or Logic Analyzers acquire digital data signals by sampling it with either an internal sampling clock or an external state clock. The acquired data is stored to the on-board memory or continuously transferred to host PC using the streaming (FIFO) mode. The acquisition can be triggered by external trigger signal or by complex pattern trigger just as known from logic analyzers.

Features and Operating Modes

Digital Data Acquisition Cards may incorporate multiple operating modes which determine how the data is acquired and stored to memory. Furthermore the cards can interact with external clock and trigger signals to organize the data acquisition.

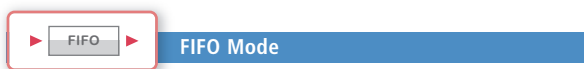

The FIFO mode is designed for continuous data transfer between the data acquisition card and the PC memory or hard disk. It uses the complete on-board memory as a real FIFO buffer, making the transfer extremely reliable. Data is transferred over the bus by the driver without the need for the user to make any special setup. All Spectrum products are designed to reach maximum continuous transfer speed which can reach up to 3.4 GByte/s on a PCIe x8 Gen2 interface.



Multiple recording allows the acquisition of several trigger events without restarting the hardware. The on-board memory is split into segments and for each trigger event one segment is recorded. The segment size and the pre- and posttrigger settings can be freely defined. The powerful combination of a small re-arming time and FIFO mode makes it easy to adapt to nearly every measurement task.



Acquisitions can be triggered by either dedicated trigger signals that have separate inputs or a by a programmable pattern trigger. Furthermore a combination of both is usable with a conjunction of OR or AND.



A sampling clock can be fed in from an external source. For synchronous sampling this source can be used as reference clock for the internal sampling clock. Furthermore this source can also be treated as a state clock with a programmable clock delay and direct sampling on the clock edge (SDR and DDR) – independent of any frequency changes or even clock gaps.



With Gated Sampling the acquisition is controlled by an external gate signal. Data is only acquired if the gate signal has reached a programmed level. Before and after each gate a programmable number of samples will be acquired in addition.

Gated Sampling can be combined with timestamps for time-correct positioning of the gate segments and to determine the length of each acquired gate segment.



The Timestamp mode writes the time positions of the trigger events into an extra memory. The Timestamps are relative to the start of recording, to a defined zero time or externally synchronized to the seconds signal from a radio clock or a GPS receiver. With this mode acquisitions of systems in different locations may be set in a precise time relation.

The Timestamp memory is designed as a FIFO buffer allowing the readout of Timestamps also in FIFO mode.

77xx Series – 32 Channel Digital Waveform Acquisition

- Up to 720 MBit/s sampling rate in timing analysis mode
- Up to 700 MBit/s DDR sampling rate in state clock mode
- State clock with gaps allowed
- Programmable clock delay
- Differential interface version (for LVDS, (LV)PECL, (N)ECL and other differential signals)
- Single-ended interface version for logic levels 1.2 V, 1.5 V, 1.8 V, 2.5 V, 3.3 V, 5.0 V
- 4 GByte on-board memory (1 GBit per channel)

Technical Details

Available Inputs	Data D0 to D31, Trigger (TrigIn), Strobe, Clock (ClkIn), X0, X1
Differential Interface	LVDS, LVPECL, PECL, (N)ECL, universal differential inputs
Single-Ended Interface	compatible to 1.2 V, 1.5 V, 1.8 V, 2.5 V, 3.3 V, 5.0 V (LV)TTL and (LV)CMOS logic levels
Input Coupling	DC
Input Type	High-speed comparator with 25 mV hysteresis (Differential Input) High-speed comparator with programmable threshold (Single-Ended Input)
Input Termination	125 Ω differential termination (Differential Input) 75 Ω / 4.7 k Ω separately programmable (Single-Ended Input)
Open Inputs	fail save -> defined and fixed input level with open inputs, no external termination necessary
Trigger Modes	External, Software, Pattern Trigger
Acquisition Modes	Single-Shot, FIFO, Multiple Recording, Gated Sampling
Trigger Delay	programmable up to 8 GSamples
Re-Arming Time	40 samples
Clock Modes	Internal, External Reference Clock, State Clock
Clock Setup Granularity	1 Hz
External Reference Clock	10 MHz to 1 GHz
State Clock	SDR with programmable clock edge, DDR, gaps allowed
Multi-Purpose I/O	Input: Asynchronous Digital-In, Timestamp Reference Clock Output: Asynchronous Digital-Out, Trigger Out, Status, PLL Reference Clock

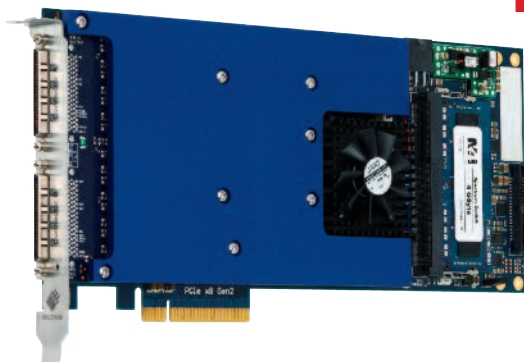

M4i
series

PCI Express

- PCIe x8 Gen2 Interface
- up to 3.4 GByte/s streaming rate
- Star-Hub for internal synchronization up to 8 cards
- 243 mm single-slot card
- 2 VHDCI Connectors

Sampling Rate	State Clock	Channels
125 MBit/s	125 MBit/s	32
250 MBit/s	250 MBit/s	32
720 MBit/s	700 MBit/s	32

Single-Ended	Differential
M4i.7710-x8 32 x 125 MS/s	
M4i.7720-x8 32 x 250 MS/s	M4i.7725-x8 32 x 250 MS/s
M4i.7730-x8 32 x 720 MS/s	M4i.7735-x8 32 x 720 MS/s

Turn-Key High-Performance Streaming Systems

Sold in the European Union only, white paper for self-setup available

- Continuous (seamless) data recording
- Guaranteed streaming speed up to 3 GByte/s
- Complete turn-key PC solution
- Data storage options from 1 to 96 Terabyte
- Single-Shot and Multiple (segmented) acquisition modes
- Sampling rates up to 5 GS/s (segmented) and 2.5 GS/s (single-shot)
- Configurations with 1 to 128 channels in one chassis
- Configurations up to 256 channels with docking station
- SBench 6 software for easy control, display and analysis
- Factory integrated and performance tested

Streaming to disk up to 3 GByte/s

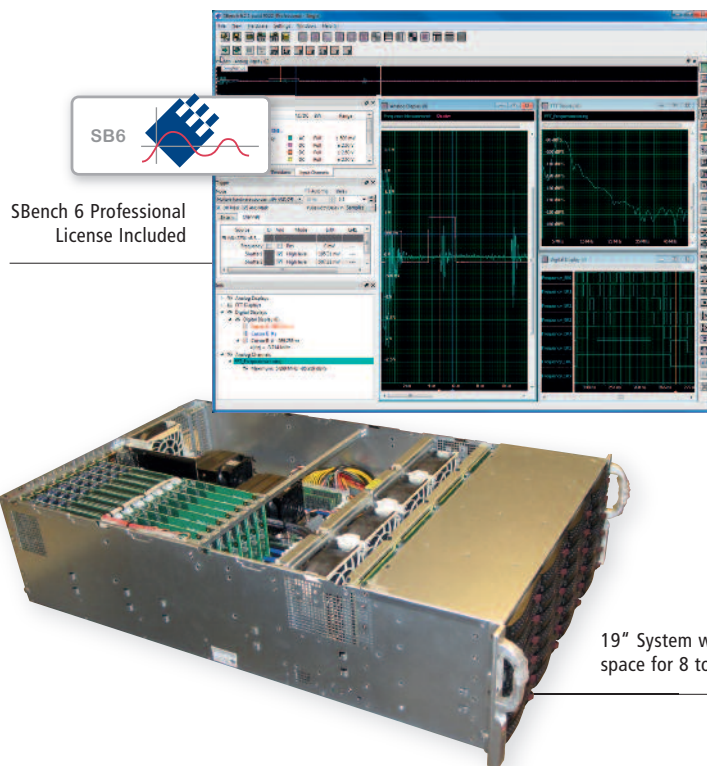

19" System with 24 drive bays and space for 8 to 10 Spectrum cards



Tower System with 8 drive bays and space for 6 Spectrum Cards

Combining a number of Spectrum M2p or M4i PCIe digitizers with a Tera-Store Data Streaming solution allows the capture and storage of long complex signals for extended periods of time. With systems offering from 1 to 96 TB of storage and streaming rates up to 3 GB/s signals can be digitized and stored seamlessly for hours on end.

At the heart of the system is a carefully selected base PC system. As a choice a Supermicro 4U/Tower with 8 drive bays and 6 free PCIe slots for Spectrum cards or a Supermicro 19" system with 24 drive bays and 8 to 10 free PCIe slots for Spectrum cards are available. The PCs are powered with Xeon Quad Core CPUs and are equipped with a separate 256 GB SSD for the system installation, low-noise power supplies and sufficient memory. The plug-in cards have additional mechanical fixtures to avoid any vibration problems.

For large multi-digitizer systems Spectrum also provides the Star-Hub, a unique clock and trigger distribution system, which allows all the installed digitizer cards of one family to be clocked synchronously and to share a common trigger. The Star-Hub is already included in the base system. Storage systems are available offering a range of streaming rates, from 500 MB/s up to 3 GB/s, and storage capacities, from 1 TB to 96 TB. The options consist of a high performance RAID controller and a number of solid-state or hard-disk drives (SSD/HDD) configured to support the required transfer rates and storage times. Spectrum integrates the complete system, providing factory configuration and performance testing. This includes the PC setup, software and hardware installation and digitizer calibration. Hardware and software are both optimized and tested to guarantee the specified streaming rates.

Multi-Card PC Systems and Docking Stations

Sold in the European Union only

All Spectrum cards can be operated in standard off-the-shelf PC systems. Using world-wide standards like PCI Express or PXI Express and latest operating system drivers ensures compatibility and offers an extremely wide choice of PC components to be used with the Spectrum products.

Standard PC technology offers a maximum of 7 slots where 4 to 6 of them are available to Spectrum cards. Looking at power consumption and heat dissipation of the high-performance instruments a good cooling concept and sufficient power supply is mandatory.

To help customers building high performance card-based systems Spectrum is also offering full running and installed systems. For up Configurations with 1 to 128 channels in one chassis to 8 cards the streaming base system shown on page 32 can be used. For more cards per system or for expansion systems there are plenty of solutions that have been individually built based on standard components:



External 3 slot PCIe docking station. Small expansion box for a standard PC (PCI Express) or a Laptop (Thunderbolt)

19" 5U system with 18 slot backplane and 16 PCIe slots available for Spectrum cards. Allows to run up to 256 channels in a single chassis.

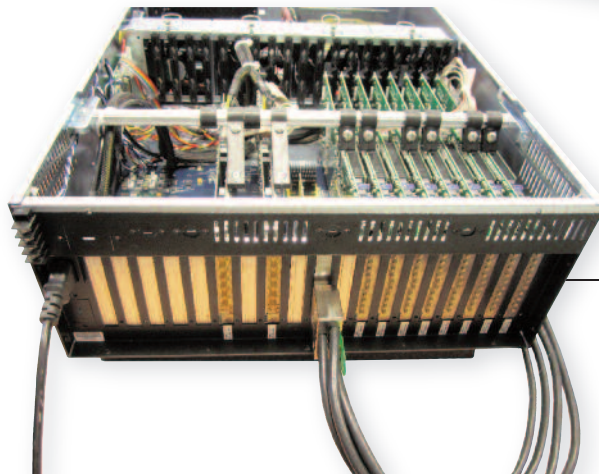
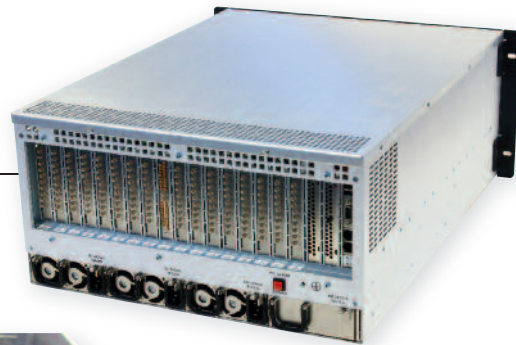

External 16 slot PCIe docking station. Expansion box for a standard PC bringing 16 PCIe slots into any host system.

Accessories



Adapter Cables

Matching the variety of different signal and auxiliary connections Spectrum is offering a complete range of adapter cables using proven industrial shielded connections. Supported connections are SMA, BNC, SMB and MMCX, all in male and female style.

For high-speed digitizers with signal frequencies way above 100 MHz, special low loss adapter cables are available.

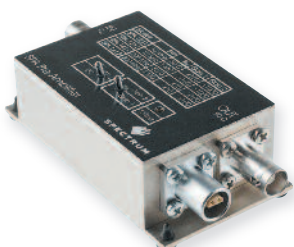

External Amplifiers

Independent external pre-amplifiers allow to acquire extremely small signals down into the low μV range with a reasonable quality. The external amplifiers are optimized for low noise inputs. The amplifiers of the SPA series are available with different bandwidth and input impedance options. No programming is needed to operate these amplifiers.

Software

The connecting link between the user and the hardware is always the software. The wide range of software products supported by Spectrum allows the user to select the software that they want:

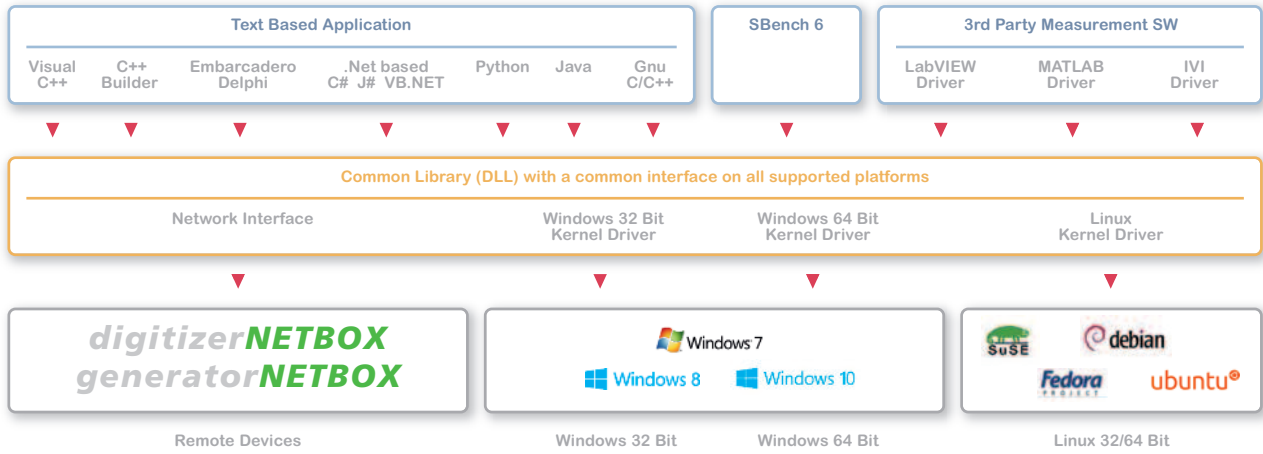

▶ Operating System Drivers

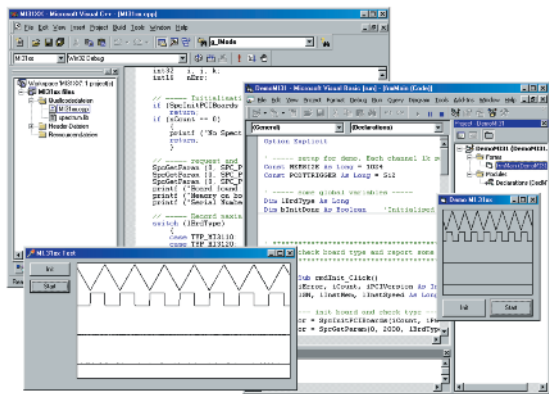

The standard driver is available for different operating systems and is programmed everywhere in the same way. This allows an easy change from one operating system to another without major changes in the source code.

The complete SDK including all drivers and examples is delivered with the hardware and updates are available from the Spectrum homepage at any time. There are **no additional SDK fees!**

The driver has a common interface for all products allowing an easy switch from one card type to another without big changes in the software. The different functionality of the products is realized with the help of board specific software registers. Programming examples are

available for different languages as seen in the above overview picture. Due to the simple yet powerful interface of the driver, the integration in other programming languages or special measurement software is an easy task.

The number of examples is continuously increasing giving more detailed programming examples that allow an easy start with the Spectrum products.

▶ Linux Support

In many areas Linux has proven itself as a high-quality alternative to Windows. Also the instrumentation market uses more and more Linux-based systems. For many years Spectrum has provided loadable Linux kernel modules for all its products for the most common Linux distributions. We also support less common Linux versions. To make this possible the source code of the driver module and the required makefiles are available from Spectrum. The user can then compile a perfectly matching version for his Linux installation.

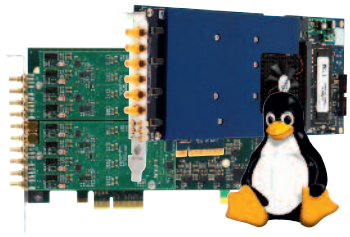

Linux driver delivery contains driver modules for more than 50 different Linux distribution versions, including the latest version of openSUSE, Fedora, Ubuntu and Debian, each as 32 bit and 64 bit kernel module.

Besides the Linux drivers Spectrum is giving full Linux support for all current software products. The Linux version of the Spectrum Control Center allows all card maintenance including firmware updates, calibration and test programs. Using the Linux versions of SBench 6 provides a fully functional data acquisition and streaming application under Linux. Both programs are made from the same source code as the Windows version giving Linux users full features and functions on the same level as Windows users. There's no development or porting delay between versions.

▶ Spectrum Remote Server

Using the Spectrum Remote Server it is possible to access the M2p/ M2i/ M3i/ M4i/ M4x card(s) installed in one PC (server) from another PC (client) via local area network (LAN), similar to using a digitizerNETBOX. The remote server option has to be activated by software license in any of the Spectrum cards in the remote system to operate it.

It is possible to use different operating systems on both server and client. For example the Remote Server is running on a Linux system and the client is accessing them from a Windows system.

Access to the remote cards is done through a transparent internal link of the Spectrum driver. There is no difference in accessing remote cards from accessing local cards.

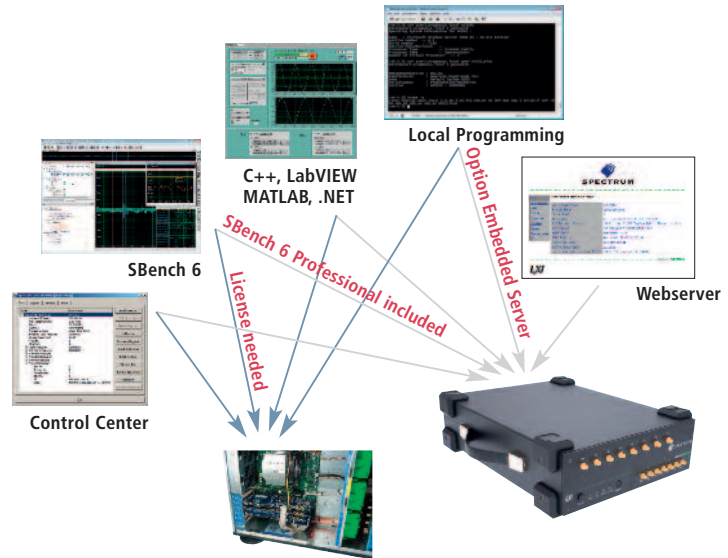

▶ LabVIEW

LabVIEW – the most common graphical programming language for measurement applications – is very well supported by the Spectrum digitizer hardware with the use of dedicated LabVIEW drivers. They combine different functions into functional blocks and make them available within LabVIEW. The LabVIEW driver package consists of several different dynamic libraries (LLBs) and some open example VIs showing the use of the driver. Besides these libraries all driver functions can also be directly called.

The LabVIEW driver supports all LabVIEW for Windows versions starting with LabVIEW 2015 up to the current version. All new product releases are installed on our test systems and all examples are immediately checked against the latest version.

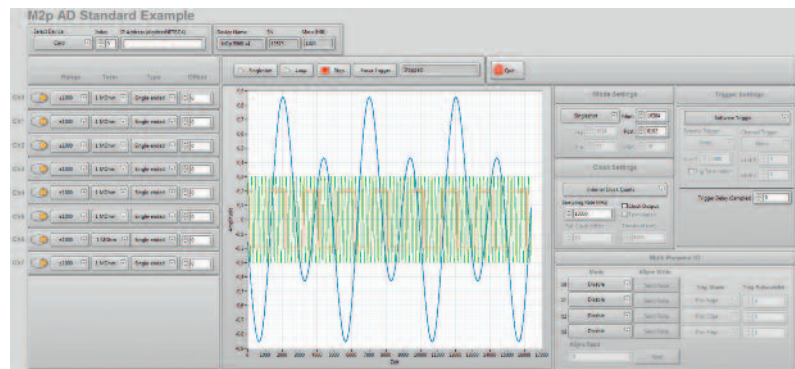

▶ MATLAB

The math software packet MATLAB from The Mathworks Inc. is supported starting from version 7.7 (R2008b). Both Windows and Linux versions are supported. The MATLAB driver consists of a set of Mex-files to access the Spectrum library and a bunch of examples in m-language. All features of the hardware can be accessed. The interface also offers an easy way to use the Spectrum cards with Simulink.

For control of the Spectrum products under MATLAB only the base version of the software package is necessary, no additional software options and toolboxes are required.

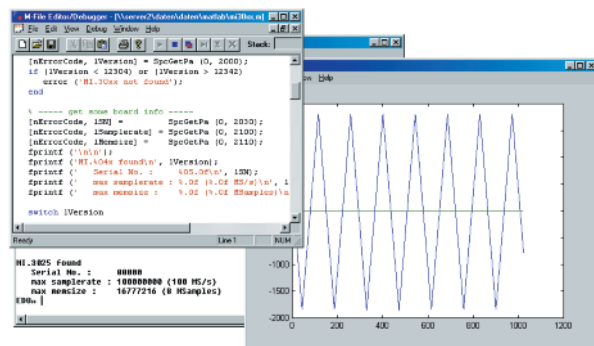

▶ IVI Drivers

All digitizer and AWG products from Spectrum for PCI Express, PXI Express and LXI bus also support the IVI class drivers IVI Digitizer, IVI Scope and IVI FGen. The IVI drivers allow users to access instruments of one function class with a common software interface independent of the manufacturer of the hardware. This makes it possible to use software, based on an IVI instrument driver, with many of the different digitizers or scopes available on the market.

▶ SDKs for text-based programming languages

The Spectrum standard API allows the access from various programming languages. The complete API is simple to use yet powerful in functionality. All programming is done using software registers and therefore only a handful of functions is needed. Including the API into a programming environment is a simple task.

Available Examples

Included in the delivery are examples for different measurement tasks for different programming environments. A huge number of setups is supported as a standard. This gives an easy and fast start with the programming:

- Visual Studio C/C++, Gnu C++
- VB.NET, C#, J#
- Delphi
- Python
- Java
- MATLAB (m-language)
- CUDA/SCAPP (optional)

▶ Control Center and Demo Mode

A special Control Center is available for the Spectrum M2i/M3i/M4i/M4x/M2p/digitizer-NETBOX/generatorNETBOX products as a stand-alone application and add-on for the drivers. This powerful tool is delivered with the cards and available under Windows and Linux and groups together all hardware maintenance functions:

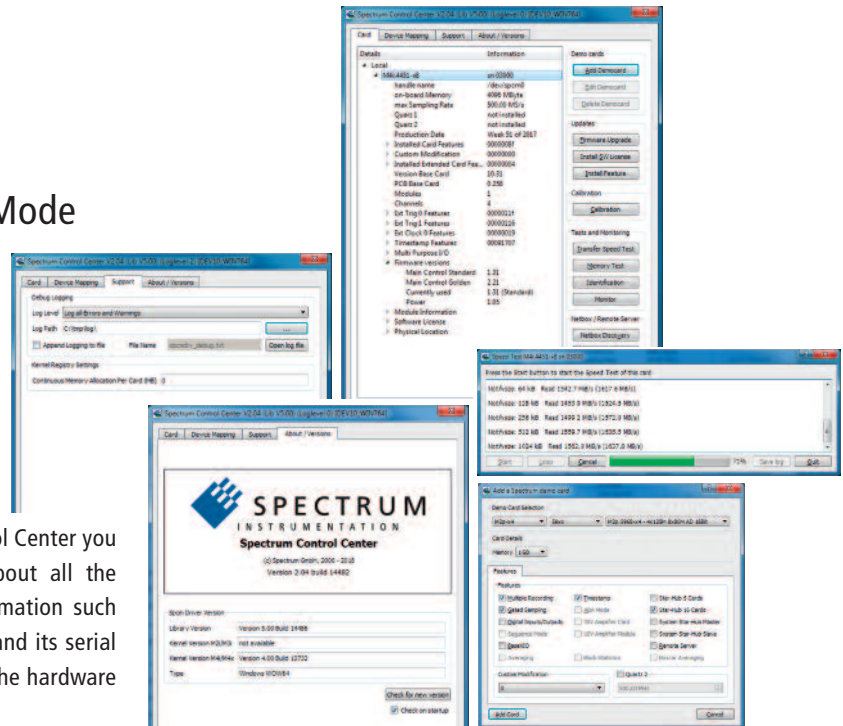

- Hardware information:** Using the Control Center you can easily get the main information about all the installed Spectrum hardware: Basic information such as the type of card, the production date and its serial number as well as the installed memory, the hardware revisions or the installed firmware.
- Installation of demo cards:** With the help of the Control Center one can install demo cards in the system. A demo card is simulated by the Spectrum driver including data generation for acquisition cards. As the demo card is simulated on the lowest driver level all software can be tested including SBench 6, own applications and drivers for third-party products like LabVIEW.
- Debug logging:** The setup of the card, driver and firmware version, all command sequences and other information can be logged to an ASCII file and can then be used for support cases.
- Features and Software license:** SBench 6 software licenses as well as all optional features of the products, that do not require any hardware modifications, can be installed on fielded cards. The customer will get a personalized upgrade code for installation.
- Firmware upgrade:** All supported products can have a later firmware upgrade to install new functions and to fix bugs. Firmware upgrade runs under Windows and Linux.
- Calibration:** The Control Center also provides an easy way to access the automatic card calibration routines of the Spectrum A/D converter cards. Depending on the used card family this can affect offset calibration only or also might include gain calibration.
- Memory test:** The complete on-board memory of the Spectrum products is tested with randomized data for proper functionality. Any read or write errors are documented.
- Transfer speed test:** Measures the bus transfer speed of an installed Spectrum card in the specific system. This gives you a performance index of the system and shows which sustained data rates can be reached.
- Netbox Discovery:** Find all digitizerNETBOX and generatorNETBOX products as well as installed Spectrum Remote Servers connected via LAN to this system. The Spectrum LXI products can be directly accessed, the integrated webserver can be called or a special monitor can be started.

For applications requiring high performance signal and data processing Spectrum offers SCAPP (Spectrum CUDA Access for Parallel Processing). The SCAPP SDK allows a direct link between Spectrum digitizers and CUDA based GPU cards. Once in the GPU users can harness the processing power of the GPU's multiple (up to 5000) processing cores and large (up to 24 GB) memory. SCAPP uses an RDMA process to send data at the digitizer's full PCIe transfer speed to the GPU card.

Spectrum's SCAPP

The Spectrum approach uses a standard off-the-shelf GPU, based on Nvidia's CUDA Standard. The GPU connects directly with the Spectrum digitizer card, with no more CPU interaction, opening the huge parallel core architecture of the CUDA card for signal processing. The structure of a CUDA graphics card fits very well as it is designed for parallel data processing, which is exactly the same as most signal processing jobs. For example, the processing tasks of data conversion, filtering, averaging, baseline suppression, FFT window functions or even FFTs themselves can all be easily parallelized.

Details

The SCAPP driver package consists of the driver extension for Remote Direct Memory Access (RDMA) that allows the direct data transfer from Digitizer to GPU. It includes a set of examples for interaction with the digitizer and the CUDA-card and another set of CUDA parallel processing examples with easy building blocks for basic functions like filtering, averaging, data de-multiplexing, data conversion or FFT. All the software is based on C/C++ and can easily be implemented and improved with normal programming skills. Starting with tested and optimized parallel processing examples gives first results within minutes.

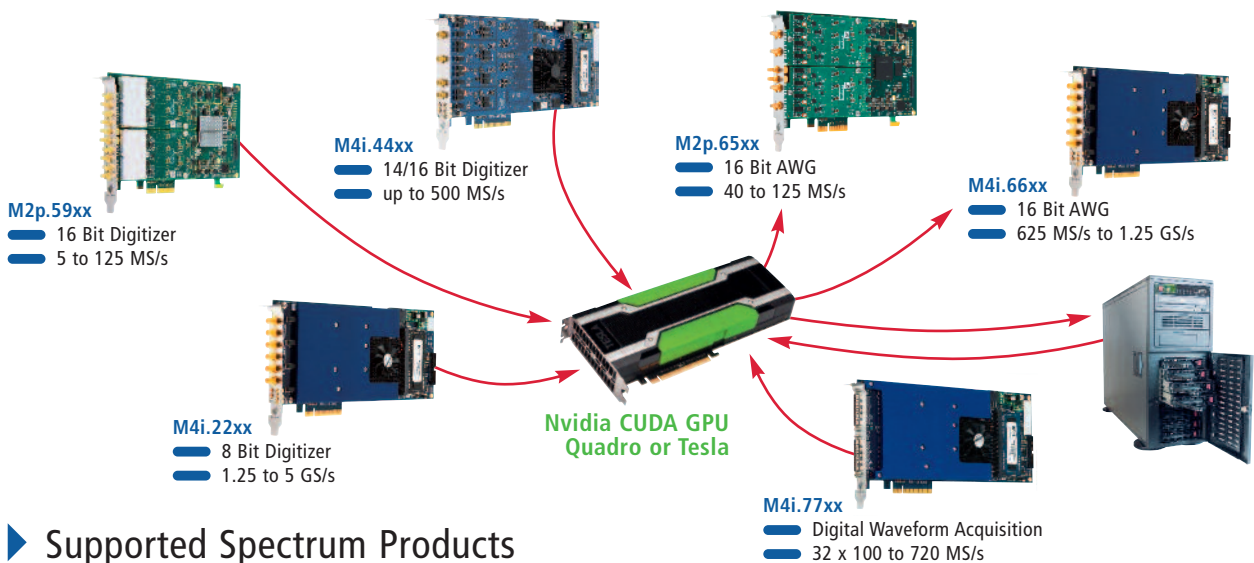

Supported Spectrum Products

- M4i.44xxx-8: 14/16 Bit digitizer up to 500 MS/s and up to 4 channels
- M4i.22xx-x8: 8 Bit digitizer up to 5 GS/s and up to 4 channels
- M4i.66xx-x8: 16 Bit AWG up to 1.25 GS/s and up to 4 channels
- M4i.77xx-x8: 32 channel digital data acquisition up to 720 MS/s
- M2p.59xx-x4: 16 Bit digitizer up to 125 MS/s and up to 8 channels
- M2p.65xx-x4: 16 Bit AWG up to 125 MS/s and up to 8 channels

The SCAPP package FFT example reaches continuous, gap-free FFT with a 1 MPoint block size on 4 channels with a sampling speed of 430 MS/s.

What is needed?

- Motherboard with two free PCIe slots: one for the CUDA graphics card and one for the Spectrum card.
- Spectrum card with enabled SCAPP option
- NVIDIA CUDA 5.0 or above graphics card of Quadro or Tesla series
- NVIDIA Nsight SDK for CUDA programming
- NVIDIA CUDA toolkit
- Linux operating system for direct data transfer with RDMA
- Windows operation system with double DMA and data copy



Potential Calculation Functions for SCAPP

- Digital filtering
- Baseline suppression
- FFT
- Block average
- Boxcar average
- Digital pulse processing
- Image calculation
- Digital down conversion
- Combination of above

And many more ...

SBench 6



This easy-to-use software provides convenient and fast data acquisition and analysis of GBytes of analog and digital data together with powerful export functions.

SBench 6 is powerful and intuitive interactive measurement software. SBench 6 allows you to commence making measurements immediately, without programming, and enables hardware setup, data display, oscilloscope, transient recorder, analysis and export functions all under one easy-to-use interface.

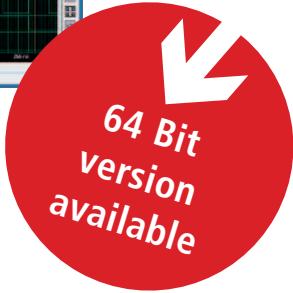
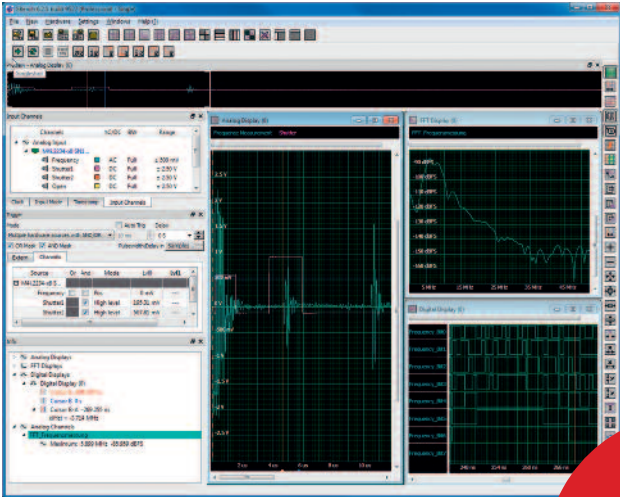

- Available for Windows 7 / Windows 8 / Windows 10 (32 / 64 bit)
- Available for Linux KDE / GNOME / Unity (32 / 64 bit)
- Fast data acquisition supporting RAID disk arrays
- Designed to acquire and handle GBytes of data
- Display of analog data (scope), X-Y data, chart recorder and frequency spectrum
- Integrated analysis functions
- Import and export filter
- Enhanced cursor functions
- Fast data preview function
- State-of-the-art drag-and-drop technology
- Thread based program structure, optimized to run with today's multi-processor technology
- Easy usage with docking windows and context menus

Setup Windows

All the hardware settings of the Spectrum instrument can be accessed using sophisticated tabbed setup windows. All setup windows can be docked whenever it is required to have a full overview of the configuration. Input signals can be scaled and given an individual unit to show real world measured values, compensating for sensor characteristics. The scaling and units are then used throughout the complete SBench software, be it in the display screen or in the calculation results. The look and feel of SBench 6 can be customized by locating setup widgets wherever necessary and by the individual configuration of toolbars and shortcuts. Each layout can be stored separately in a user file that can be used for future sessions of SBench 6.

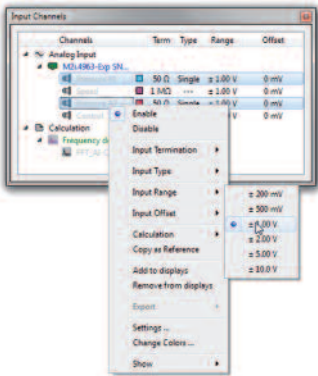

Acquisition and Replay

SBench 6 is able to act as a recorder as well as a generator front-end. The software is able to replay GBytes of either analog or digital data from various sources. Data can be imported from different file formats as well as using previously acquired data. SBench 6 automatically re-scales and converts data to allow the use of acquisition and replay cards of different resolutions and channel count.

Data Storage

The SBench 6 engine controls the complete data transfer whether into the PC RAM or onto hard disk. The streaming engine supports different binary formats that may be used for data storage. This eliminates all time-consuming conversion jobs after the end of the acquisition. Data files can be automatically split into smaller pieces even while writing data. SBench 6 has been optimized for working with multi GByte data files. The technology makes it possible for SBench 6 to handle data from up to 4 GBytes of on-board memory as well as hard disk recordings of several GBytes.

FFT Analysis and Display

Using the FFT calculation turns the oscilloscope like software into a spectrum analyzer. The FFT function converts time domain signals into the frequency domain. The input signal can be weighted by different window functions like Hanning, Hamming, Blackman, etc., with the resulting FFT plot being shown as dBc, dBFS, dBuV, dBm or plain voltage. The FFT analysis function can generate Amplitude, Phase and PSD (Power Spectrum Density) plots. The resulting FFT signal can also be used for further calculations like SNR, THD, MAX value or others.

FFT Analysis, like all calculation functions, can run on full signals, on the visible signal area in one display or on a selected area between cursors.

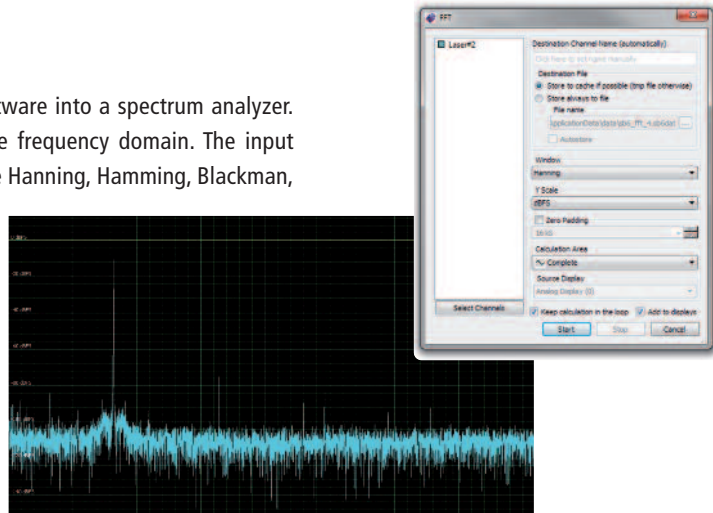

Calculation Routines and Measuring Results

A special info window shows extended information on the current cursor positions within the display windows. Each cursor can be locked on a signal showing the precise values for the signal. Using both cursors makes it possible to obtain some simple measurement functions and, with only one mouse click, it is possible to use additional calculation routines on any signal. The signal used can be any acquired signal, any loaded signal or even a freshly calculated signal like an FFT, allowing fully nested calculations. The calculation area can be selected to be the whole signal, an area that is shown inside the display window, or the segment defined by the two cursor positions.

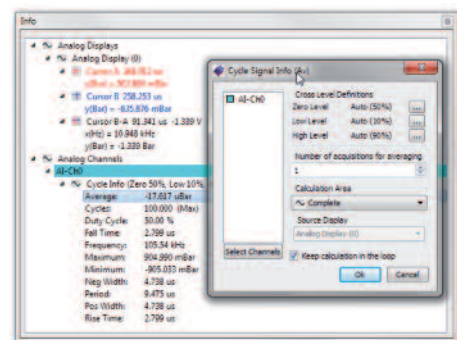

Calculation Plug-In Interface

SBench 6 offers a versatile plug-in interface that allows to extend the software by own calculation functions. The plug-in interface allows to define different setup fields and receives a number of acquired or calculated signals. The resulting signals are handled just like every other SBench 6 signal and can be displayed, exported or used for reports. The interface is based on C++ and runs under Windows and Linux. Examples are included.

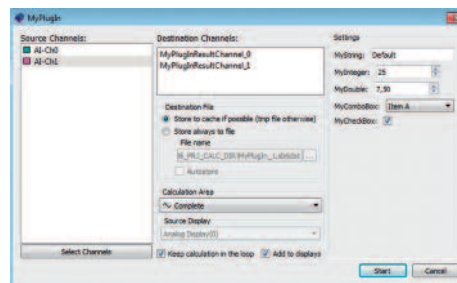

Digital Data Display (Logic Analyzer)

Besides the acquisition and display of analog data SBench6 also contains a powerful digital data display for grouping signals into a bus and to navigate through data by edge detection and pulse measurements. The digital data display is available for pure digital acquisition cards as well as for additional digital inputs of an analog data acquisition card. Analog data can be converted to digital data and vice versa to combine different signals into a mixed mode display. Digital displays and analog displays can be synchronized to have cursor and zoom settings automatically synchronous between different displays for comprehensive Mixed Signal Analysis.

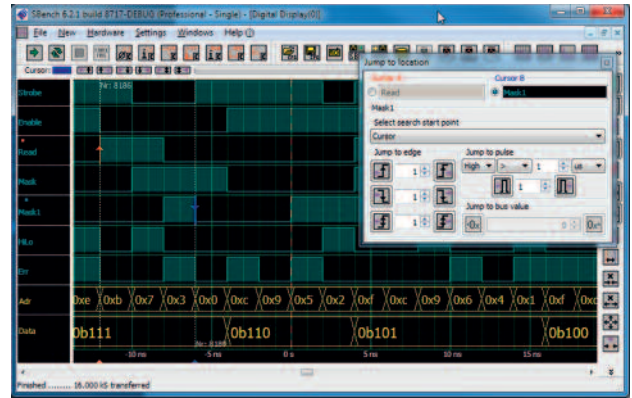

Project Organization

The entire configuration, acquired data, reports, calculations and stored files are placed within a separate project folder. Projects can be used to organize measurement setups in production, to store, archive and share complete data sets, including all calculation and display details, or to generate default and write protected project templates for specific measurement jobs. A project is either stored as a set of sub-folders with separate files, which can be accessed individually, or it can be stored as a zip-archive that can be easily exchanged.



The project and also the separate data acquisitions can be extended by a user defined number of additional information fields. These can be made mandatory in cases that need to have a defined data set for each acquisition. The information fields can hold environmental details like temperature, used equipment, operator, additional test settings or it can be used to describe the DUT (device under test).

A project can hold a single acquisition as well as a number of automatically or manually stored acquisitions. All acquisitions can be found in a separate project data browser that also displays the acquisition information on the side.

Reports

SBench 6 contains a powerful report editor and generator that documents the use of all components of SBench 6 for individual reports.

A report can contain analog, FFT, digital, histogram, spread and X-Y displays. Furthermore, all measurement results, cursor positions, project information, hardware information and the complete hardware configuration can be added to a report as single values or as overview tables.

Free text fields, lines and pictures can be used to add additional information to the report.

The report template itself is XML code and can be changed manually or archived with standard code managing software. The report is generated as a PDF-file and can be printed on any installed printer or stored as a pdf file. Different European and US paper formats are supported with freely definable borders, header and footer area.

The printout can be made in portrait or landscape format.

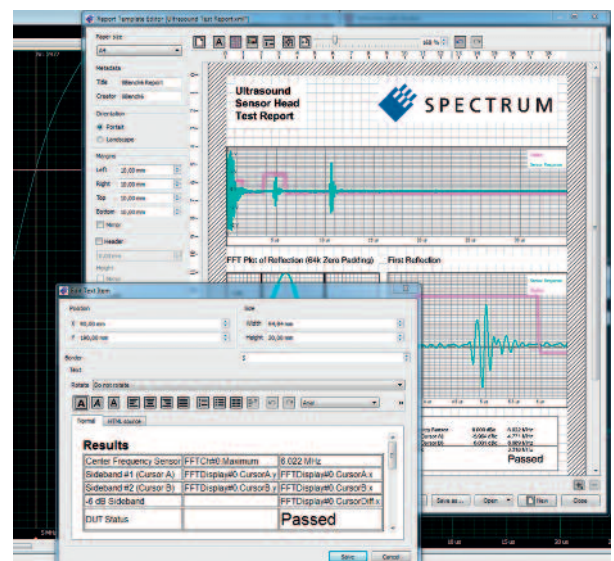

▶ 1. World-leading Digitizers and Arbitrary Waveform Generators

SPECTRUM produces ultra-fast and high-resolution products for signal capture and signal generation.

▶ 2. Many product variations

SPECTRUM uses a unique modular design of platform-boards and many different modules to create a wide range of products.

▶ 3. Perfect Fit solutions

Thanks to the modular design, every customer gets exactly their specifications, available from stock, and at a competitive price.

▶ 4. Backwards compatibility

SPECTRUM offers compability, advice, service and repairs for all its products of the last 20 years.

▶ 5. Fast time to market

Design cycles are fast at SPECTRUM, because new modules are combined with proven platform-boards.

▶ 6. Own software

SPECTRUM offers the easy-to-use and feature-rich "SBench 6" control software.

▶ 7. World class support

Customers get direct access to SPECTRUM's hardware & software engineers.

▶ 8. German quality built in since 1989

All SPECTRUM products are fully designed, produced and extensively tested in Germany.

▶ 9. Five year warranty

SPECTRUM offers an industry-leading 5-year warranty for your long-term peace of mind.

▶ 10. Satisfied customers

Multinational companies and leading research institutions rely on our products for leading-edge, long-term projects.

To keep engineers and scientists up to date with the latest developments in PC based digitizer technology Spectrum has published a handbook that covers the major product features of this powerful class of instrument and also explains when a digitizer can replace an oscilloscope. The 120 page booklet is printed in full color and includes a number of graphical images that highlight and explain key digitizer concepts and their application.

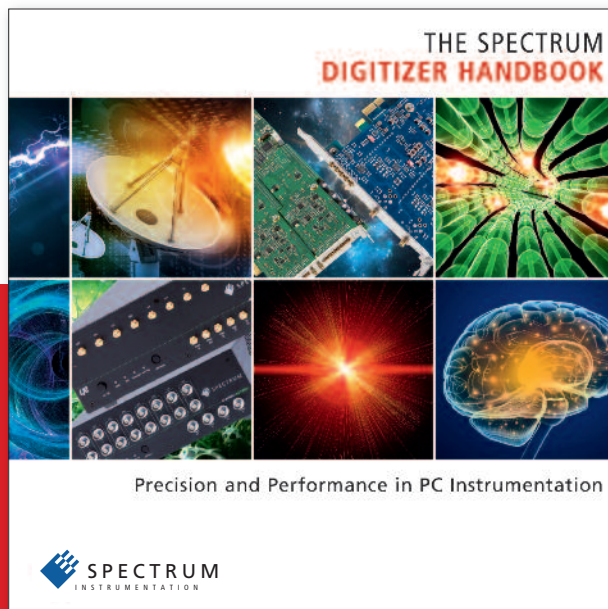

Request your free copy of the Digitizer Handbook directly at Spectrum

Social Media

Spectrum regularly releases new products, new features, application and product notes, new software and driver versions or new videos. Follow Spectrum on one of the social media platforms to stay up-to-date:



www.linkedin.com/company/spectrum-instrumentation



www.twitter.com/SpecInstruments



www.facebook.com/SpectrumInstrumentation



www.youtube.com/user/SpectrumGermany

Imprint

Editor

Spectrum Instrumentation GmbH
Ahrensfelder Weg 13-17,
22927 Grosshansdorf / Germany
Phone: +49 (0)4102-6956-0
Fax: +49 (0)4102-6956-66
E-Mail: info@spec.de
Web: spectrum-instrumentation.com

Trademarks / registered trademarks

Microsoft, Visual Basic, Visual C++, Visual C#, Visual J#, Visual Studio, Windows, Windows XP, Windows Vista, Windows 7, Windows 8 and Windows 10 are trademarks or registered trademarks of Microsoft Corporation.

LabVIEW is trademark or registered trademark of National Instruments Corporation.

Delphi and **C++Builder** are trademarks or registered trademarks of Embarcadero Technologies, Inc.

MATLAB is a trademark or registered trademark of The MathWorks, Inc.
PCI-SIG, PCI, PCI-X and the **PCI EXPRESS/PCIe** design mark are registered trademarks and/or service marks of PCI-SIG.

SBench, digitizerNETBOX and **generatorNETBOX** are registered trademarks of Spectrum Instrumentation GmbH.

LXI and the **LXI logo** are trademarks of the LXI Consortium Inc.

IVI is a registered trademark of the IVI Foundation.

PXI is a trademark of the PXI Systems Alliance.

Oracle and **Java** are registered trademarks of Oracle and/or its affiliates.

Nvidia, Nsight and **CUDA** are trademarks of the NVIDIA Corporation.

Changes and copyright

Additional adaptations and changes may be necessary to the products for their technical development. We take no liability for erroneous values or printing errors.

Copyright © 2020 by Spectrum Instrumentation GmbH. Reprinting and copying is only allowed with a written permission. All rights reserved.



Australia



Austria



Belgium



Canada



China



CIS



Denmark



Finland



France



Germany



Great Britain



India



Ireland



Israel



Italy



Japan



Korea



Luxembourg



Malaysia



Netherlands



New Zealand



Norway



Philippines



Russia



Singapore



Sweden



Taiwan



Thailand



USA



We are headquartered in Grosshansdorf near Hamburg / Germany and operate worldwide through dedicated regional teams.



SPECTRUM
INSTRUMENTATION

Spectrum Instrumentation GmbH

Ahrensfelder Weg 13-17 | 22927 Grosshansdorf | Germany

Phone +49 (0)4102-69 56-0 | Fax +49 (0)4102-69 56-66

info@spec.de



SPECTRUM
INSTRUMENTATION CORP.

Spectrum Instrumentation Corp

401 Hackensack Ave, 4th Floor | Hackensack, NJ 07601 | USA

Phone +1 (201) 562-1999 | Fax +1 (201) 342-7598

sales@spectrum-instrumentation.com



spectrum-instrumentation.com